

RS507/RS507X

Hands-Free Imager

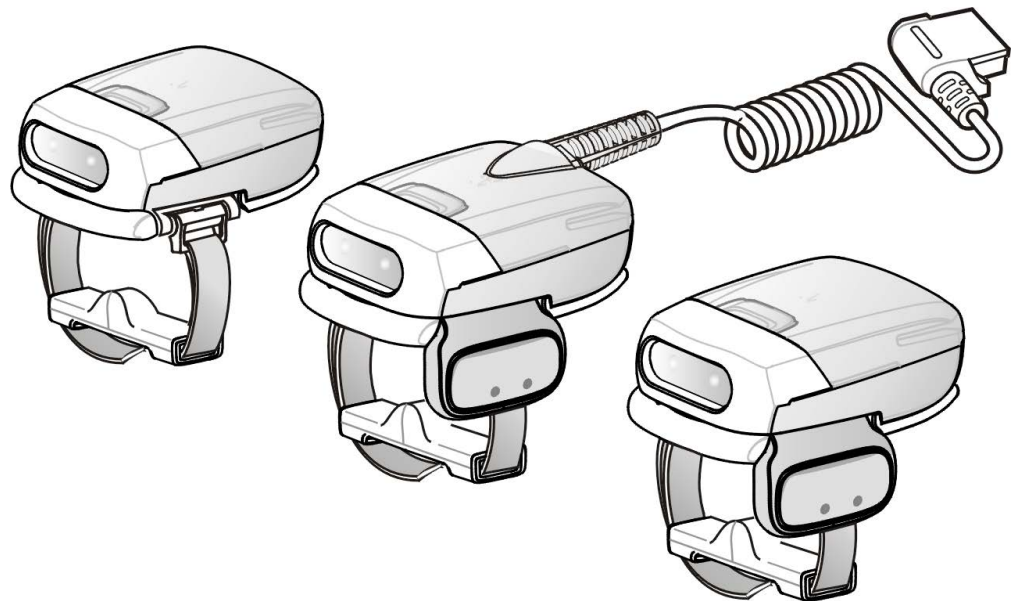

Product Reference Guide



ZEBRA

Copyright

ZEBRA and the stylized Zebra head are trademarks of Zebra Technologies Corporation, registered in many jurisdictions worldwide. All other trademarks are the property of their respective owners.

© 2023 Zebra Technologies Corporation and/or its affiliates. All rights reserved.

Information in this document is subject to change without notice. The software described in this document is furnished under a license agreement or nondisclosure agreement. The software may be used or copied only in accordance with the terms of those agreements.

For further information regarding legal and proprietary statements, please go to:

SOFTWARE: zebra.com/linkoslegal

COPYRIGHTS: zebra.com/copyright

PATENTS: ip.zebra.com

WARRANTY: zebra.com/warranty

END USER LICENSE AGREEMENT: zebra.com/eula

Terms of Use

- Proprietary Statement

This manual contains proprietary information of Zebra Technologies Corporation and its subsidiaries (“Zebra Technologies”). It is intended solely for the information and use of parties operating and maintaining the equipment described herein. Such proprietary information may not be used, reproduced, or disclosed to any other parties for any other purpose without the express, written permission of Zebra Technologies.

- Product Improvements

Continuous improvement of products is a policy of Zebra Technologies. All specifications and designs are subject to change without notice.

- Liability Disclaimer

Zebra Technologies takes steps to ensure that its published Engineering specifications and manuals are correct; however, errors do occur. Zebra Technologies reserves the right to correct any such errors and disclaims liability resulting therefrom.

- Limitation of Liability

In no event shall Zebra Technologies or anyone else involved in the creation, production, or delivery of the accompanying product (including hardware and software) be liable for any damages whatsoever (including, without limitation, consequential damages including loss of business profits, business interruption, or loss of business information) arising out of the use of, the results of use of, or inability to use such product, even if Zebra Technologies has been advised of the possibility of such damages. Some jurisdictions do not allow the exclusion or limitation of incidental or consequential damages, so the above limitation or exclusion may not apply to you.

Revision History

Changes to the original guide are listed below:

Change	Date	Description
-07 Rev A	2/2023	Update the default value of Interleaved 2 of 5 (ITF) to Enabled.
-06 Rev A	12/2020	Replaced master/slave references with central/peripheral
-05 Rev A	5/2018	Add Image Capture mode and HID Features for Apple iOS (HID only)
-04 Rev A	11/2017	Add model number RS507X
-03 Rev A	4/2017	Correct LED indicator indications in Table 2.
-02 Rev A	3/2015	Zebra rebranding
-01 Rev B	10/2011	Add Chapter 7
-01 Rev A	10/2009	Release

Table of Contents

Copyright	2
Terms of Use	2
Revision History	3

About This Guide

Introduction	12
Documentation Set	12
Model Configurations	12
Chapter Descriptions	13
Notational Conventions	13
Related Documents	14
Service Information	14
Provide Documentation Feedback	14

Getting Started

Introduction	15
RS507 Hands-Free Imager Features	15
Unpacking	16
Cordless Configuration Features	17
Corded Configuration Features	18
Trigger Swivel Assembly - Change Trigger Position	19
Getting Started - Cordless Configuration	20
Charge the Battery	20
Install the Battery	20
Remove the Battery	20
Wearing the Imager	20
Getting Started - Corded Configuration	21
Connect the Corded Adapter	21
Remove the Corded Adapter	22
Connect to a WT4XXX Wearable Terminal	22
Wearing the Imager	23
Status Indications	23
Imager Standby Mode	25
Bluetooth Connection	25
Establish Bluetooth Connection	25
Restore Lost Bluetooth Connection	27

Table of Contents

Remove Bluetooth Connection	27
Pairing Bar Code Format	28
Scan	28
Scan Triggering Modes	28
Aiming the Imager	29
Customize the Imager	30
Changing from Triggered to Triggerless Configuration	30
Changing Triggerless to Triggered Configuration	30
Resetting the Imager	31
Warm Boot	31
Cold Boot	31
Clean Boot	31
SAC5070 8-Bay Battery Charger	
Introduction	32
Unpacking the Charger	32
Parts of the Charger	33
Installation	34
Tabletop / Shelf Set Up	34
Wall Mount	34
Inserting the Imager Battery in the Charger	35
Charge the Battery	36
Battery Age Test	36
Charge Status LED	37
Troubleshooting & Maintenance	
Introduction	38
Troubleshooting	38
Imager	38
Charger	39
Maintenance	40
Maintaining the Imager	40
Comfort Pad Replacement	40
Trigger Swivel Assembly Replacement	41
Triggerless Strap Holder Replacement	42
Finger Strap Replacement (Trigger Swivel Assembly)	43
Finger Strap Replacement (Triggerless Strap Holder)	44
Strap Buckle Replacement	45
Field Replaceable Parts	45
Cleaning the Imager	46
Maintaining the Charger	47
Operating conditions for the Charger	47
Handling the Charger	47
Cleaning the Charger	47
RS507 Update and Configuration	
Introduction	48
Configuring the Imager	48

Table of Contents

Introduction	48
Control Panel Application	49
RSMSample Application	50
Imager Attributes	53
Imager Motion and Proximity Configuration	57
.....	61
Real Time Logger	61
Imager Firmware Update	62
Required Equipment	62
Updating the RS507 Firmware	62
Miscellaneous Imager Options	
Introduction	66
Scanning Sequence Examples	66
Errors While Scanning	67
User Preferences/Miscellaneous Options Parameter Defaults	67
User Preferences	68
Set Default Parameter	68
Parameter Bar Code Scanning	69
Beep After Good Decode	69
Beeper Tone	70
Beeper Volume	71
Imager Activity Modes	72
Picklist Mode	73
Fuzzy 1D Processing	74
Decoding Illumination	75
Low Battery Indication Cycle	75
Bluetooth Disconnection Alert Control	76
Miscellaneous Scanner Parameters	78
Transmit Code ID Character	78
Prefix/Suffix Values	79
Scan Data Transmission Format	80
Scan Data Transmission Format (continued)	82
FN1 Substitution Values	82
Transmit "No Read" Message	83
Symbologies	
Introduction	84
Scanning Sequence Examples	84
Errors While Scanning	85
Symbology Parameter Defaults	85
UPC/EAN	90
Enable/Disable UPC-A	90
Enable/Disable UPC-E	90
Enable/Disable UPC-E1	90
Enable/Disable EAN-8/JAN-8	91
Enable/Disable EAN-13/JAN-13	92
Enable/Disable Bookland EAN	92
Decode UPC/EAN/JAN Supplementals	93

Table of Contents

User-Programmable Supplementals	96
UPC/EAN/JAN Supplemental Redundancy	96
UPC/EAN/JAN Supplemental AIM ID Format	97
Transmit UPC-A Check Digit	97
Transmit UPC-E Check Digit	98
Transmit UPC-E1 Check Digit	98
UPC-A Preamble	98
UPC-E Preamble	99
UPC-E1 Preamble	100
Convert UPC-E to UPC-A	101
Convert UPC-E1 to UPC-A	102
EAN-8/JAN-8 Extend	103
Bookland ISBN Format	104
UCC Coupon Extended Code	105
ISSN EAN	105
Code 128	106
Enable/Disable Code 128	106
Set Lengths for Code 128	106
Enable/Disable GS1-128 (formerly UCC/EAN-128)	107
Enable/Disable ISBT 128	108
ISBT Concatenation	109
Check ISBT Table	110
ISBT Concatenation Redundancy	110
Code 39	111
Enable/Disable Code 39	111
Enable/Disable Trioptic Code 39	111
Convert Code 39 to Code 32	112
Code 32 Prefix	112
Set Lengths for Code 39	113
Code 39 Check Digit Verification	114
Transmit Code 39 Check Digit	114
Code 39 Full ASCII Conversion	115
Code 39 Buffering - Scan & Store	115
Code 39 Buffering - Scan & Store (continued)	116
Code 93	118
Enable/Disable Code 93	118
Set Lengths for Code 93	118
Set Lengths for Code 93 (continued)	119
Code 11	120
Code 11	120
Set Lengths for Code 11	120
Code 11 Check Digit Verification	121
Transmit Code 11 Check Digits	123
Interleaved 2 of 5 (ITF)	123
Enable/Disable Interleaved 2 of 5	123
Set Lengths for Interleaved 2 of 5	124
Set Lengths for Interleaved 2 of 5 (continued)	125
I 2 of 5 Check Digit Verification	126
Transmit I 2 of 5 Check Digit	126
Convert I 2 of 5 to EAN-13	127
Discrete 2 of 5 (DTF)	127

Table of Contents

Enable/Disable Discrete 2 of 5	127
Set Lengths for Discrete 2 of 5	128
Set Lengths for Discrete 2 of 5 (continued)	129
Codabar (NW - 7)	130
Enable/Disable Codabar	130
Set Lengths for Codabar	130
Set Lengths for Codabar (continued)	131
CLSI Editing	131
NOTIS Editing	132
MSI	133
Enable/Disable MSI	133
Set Lengths for MSI	133
Set Lengths for MSI (continued)	134
MSI Check Digits	134
Transmit MSI Check Digit(s)	135
MSI Check Digit Algorithm	136
Chinese 2 of 5	136
Enable/Disable Chinese 2 of 5	136
Matrix 2 of 5	137
Enable/Disable Matrix 2 of 5	137
Set Lengths for Matrix 2 of 5	138
Matrix 2 of 5 Redundancy	139
Matrix 2 of 5 Check Digit	139
Transmit Matrix 2 of 5 Check Digit	140
Inverse 1D	140
Postal Codes	141
US Postnet	141
US Planet	141
Transmit US Postal Check Digit	142
UK Postal	142
Transmit UK Postal Check Digit	143
Japan Postal	143
Australian Postal	144
Netherlands KIX Code	144
USPS 4CB/One Code/Intelligent Mail	145
UPU FICS Postal	145
Mailmark	145
GS1 DataBar	145
GS1 DataBar-14	146
GS1 DataBar Limited	146
GS1 DataBar Expanded	147
Convert GS1 DataBar to UPC/EAN	147
Composite	148
Composite CC-C	148
Composite CC-A/B	148
Composite TLC-39	149
UPC Composite Mode	149
Composite Beep Mode	150
GS1-128 Emulation Mode for UCC/EAN Composite Codes	150
2D Symbolologies	151
Enable/Disable PDF417	151

Enable/Disable MicroPDF417	151
Code 128 Emulation	151
Data Matrix	153
Data Matrix Inverse	153
Maxicode	154
QR Code	154
QR Inverse	155
MicroQR	155
Aztec	156
Aztec Inverse	156
Redundancy Level	157
Redundancy Level 1	157
Redundancy Level 2	157
Redundancy Level 3	157
Redundancy Level 4	158
Security Level	158
Intercharacter Gap Size	159
Report Version	160
Macro PDF Features	161
Flush Macro Buffer	161
Abort Macro PDF Entry	161

Bluetooth Connection Using HID and SPP Profiles

Introduction	162
RS507 to Computer Bluetooth Connection Modes	162
RS507 Important hardware features	163
Refreshing Boot Choices	163
HID (Human Interface Device) Mode	164
How to change to HID mode	164
How to format the scanned data	165
How to pair and connect with a computer running Windows 7 SP1	165
How to pair and connect with a computer running Windows XP SP3 and Bluetooth 2.1	167
How to pair and connect with other devices	171
Reconnecting	171
How to demonstrate HID connection with a computer	171
Country keyboard type change	172
Connecting multiple RS507 into single device	173
Using random PIN code	173
How to return to SSI (SCAN) mode	177
Serial Port Profile (SPP) Mode	178
How to change to SPP mode	178
How to format the scanned data the data	179
How to pair and connect with a computer running Windows 7 SP1	179
How to pair and connect with a computer running Windows XP SP3	185
SPP connection with RS507 as a Peripheral	189
How to pair and connect with other devices	192
Reconnecting	193
How to demonstrate SPP connection with a computer	193
Connecting multiple RS507 into single device	194
Special characters	195

Table of Contents

How to return to SSI (SCAN) mode	195
Switching between SSI (SCAN), HID and SPP	195
Firmware upgrade	198
Upgrading using a computer and the PC Tool application	198
Retrieving the RS507 log file	202
Bluetooth Bar Codes	206
Bluetooth Authentication Control	206
Bluetooth Automatic Reconnection Control	207
Bell Indication Control	209
Bluetooth Profile Control	214
Bluetooth Pairing Control	215
Bluetooth Security Level Control	215
Batch Mode	216
Unique Identifier	218
Force Bluetooth Role Switch (SPP only)	218
Image Capture (SPP only)	219
HID Features for Apple iOS (HID Only)	219
123Scan and Software Tools	
Introduction	220
123Scan	220
Communication with 123Scan	220
123Scan Requirements	221
123Scan Information	221
Advanced Data Formatting (ADF)	221
Specifications	
Technical Specifications	222
Imager	222
8 Slot Battery Charger	225
Standard Default Parameters	
Standard Default Parameters Table	226
Programming Reference	
Symbol Code Identifiers	231
AIM Code Identifiers	232
Sample Bar Codes	
Code 39	237
UPC/EAN	237
UPC-A, 100%	237
EAN-13, 100%	238
Code 128	238
Interleaved 2 of 5	238
GS1 DataBar-14	238

Table of Contents

PDF417	239
Data Matrix	239
Maxicode	239
QR Code	240
US Postnet	240
UK Postal	240

Numeric Bar Codes

Numeric Bar Codes	241
Cancel	242

Index

About This Guide

Introduction

This Product Reference Guide provides additional information that is not covered by the Quick Reference Guide and is helpful for application developers and customers alike.

The Product Reference Guide provides information on operating the Imager for the first time, using the Imager, resetting and capturing data.

The guide also covers issues such as charging and testing the Imager battery, troubleshooting, maintenance, firmware update and configuration of the Imager. Sample bar codes are provided for configuring and testing the Imager.

This guide applies to Model Numbers RS507 and RS507X.

Documentation Set

The documentation set for the RS507 is divided into guides that provide information for specific user needs.

- **RS507/RS507X Hands-Free Imager Quick Start Guide** - describes how to use the Imager.
- **SAC5070 8-Bay Battery Charger Quick Reference Guide** - describes how to use the Imager charger.
- **EMDK Help File** - provides API information for writing applications.
- **Advanced Data Formatting Programmer Guide** - describes how to customize data before transmission to the host device.

Model Configurations

This guide covers the following model configurations:

- RS507-IM2xxxxSTWR -Triggered RS507 with standard battery
- RS507-IM2xxxxSNWR - Triggerless RS507 with standard battery
- RS507-IM2xxxxENWR -Triggerless RS507 with extended battery
- RS507-IM2xxxxCTWR - Corded and Triggered RS507
- RS507X-IM2xxxxSTWR -Triggered RS507 with standard battery
- RS507X-IM2xxxxSNWR - Triggerless RS507 with standard battery
- RS507X-IM2xxxxENWR -Triggerless RS507 with extended battery
- RS507X-IM2xxxxCTWR - Corded and Triggered RS507

For shipping configuration of each model option, refer to [Unpacking on page 16](#).

Chapter Descriptions

Topics covered in this guide are as follows:

- [Getting Started](#) provides information on getting the Imager up and running for the first time, basic instructions for using the Imager and instructions for resetting the Imager and capturing data.
- [SAC5070 8-Bay Battery Charger](#) provides information on charging and testing the Imager battery.
- [Troubleshooting & Maintenance](#) provides troubleshooting, cleaning, part replacement and technical specifications for the Imager.
- [RS507 Update and Configuration](#) provides instructions for firmware update and configuration of the Imager operation.
- [Miscellaneous Imager Options](#) provides information on programming the Imager to perform various functions, or activating different features.
- [Symbologies](#) details symbology features and provides programming bar codes for selecting these features.
- [Bluetooth Connection Using HID and SPP Profiles](#) describes the Bluetooth connection modes of the RS507 to a personal computer and non-Zebra terminals.
- [Specifications](#) provides Imager and charger technical specifications.
- [Standard Default Parameters](#) provides a sample of bar codes used for configuring the Imager.
- [Programming Reference](#) provides symbol code characters.
- [Sample Bar Codes](#) provides sample bar codes for Imager testing.
- [Numeric Bar Codes](#) provides a sample of numeric bar codes.

Notational Conventions

The following conventions are used in this document:

- “RS507” refers to the Zebra RS507/RS507X Hands-Free Imager.
- “Imager” refers to the Zebra RS507/RS507X Hands-Free Imager.
- “Terminal” refers to the Wearable Terminal WT4XXX or any mobile computer connected to the Imager.
- “Charger” refers to the SAC5070 8-Bay Battery Charger of the RS507/RS507X.
- **Bold** text is used to highlight the following:
 - Dialog box, window and screen names
 - Drop-down list and list box names
 - Check box and radio button names
 - Icons on a screen
 - Key names on a keypad
 - Button names on a screen.
- Bullets (•) indicate:
 - Action items
 - Lists of alternatives
 - Lists of required steps that are not necessarily sequential.
- Sequential lists (e.g., those that describe step-by-step procedures) appear as numb lists.

Related Documents

- RS507/RS507X Hands-Free Imager Quick Start Guide, p/n 72-115987-01-xx
- SAC5070 8-Bay Battery Charger Quick Reference Guide, p/n 72-115989-01-xx
- WT4090 Quick Start Guide p/n 72-86717-02-xx
- WT41N0 Quick Start Guide p/n 72-157178-xx as well as other supported terminals'

For the latest version of this guide and all guides, go to: www.zebra.com/support.

Service Information

If you have a problem with your equipment, contact Zebra Support for your region. Contact information is available at:

www.zebra.com/support.

When contacting Support, please have the following information available:

- Serial number of the unit
- Model number or product name
- Software type and version number

The following information should be available when reporting a problem:

- Customer name
- Application used
- Configuration (corded/cordless, trigger/triggerless, standard or extended battery)
- RS507 or Cradle version number
- RS507 CAB file version and OEM version
- Use the PC Tool application to retrieve and E-mail the RS507 log to the support representative
- Occurrence (always, once out of 10 attempts, etc...)
- Suggested steps to reproduce the problem

Zebra responds to calls by E-mail, telephone or fax within the time limits set forth in support agreements.

If your problem cannot be solved by Zebra Support, you may need to return your equipment for servicing and will be given specific directions. Zebra is not responsible for any damages incurred during shipment if the approved shipping container is not used. Shipping the units improperly can possibly void the warranty.

If you purchased your business product from a Zebra business partner, contact that business partner for support.

Provide Documentation Feedback

If you have comments, questions, or suggestions about this guide, send an email to EVM-Techdocs@zebra.com.

Getting Started

Introduction

This chapter describes the features of the RS507 Hands-Free Imager and explains how to install and charge the battery, capture data and reset the Imager.

RS507 Hands-Free Imager Features

The RS507 Hands-Free Imager (also referred to as the Imager) is a wearable bar code scan solution for both 1D and 2D bar code symbologies. The Imager is also compatible with a wide range of mobile computers communicating over Bluetooth.

The Imager is designed for a wide range of applications from management of products in a warehouse, to processing deliveries at a courier facility to processing prescription drugs at the pharmaceutical distribution center.

The Imager uses camera-based scanning technology, designed to offer flexible hands-free operation with ergonomic comfort for right or left hand users.

Unpacking

Carefully remove all protective material from around the equipment and save the shipping container for later storage and shipping.

After opening the shipping box, inspect the contents. You should have received the following:

Table 1 RS507 Shipping Configuration Model Options

Model yy: IM = SR focus DL = DL focus z: blank = RS507 (legacy) x = RS507X (new)	Description	Standard Battery	Extended Battery	Corded Adapter	Trigger	Quick Reference Guide or Regulatory Guide
RS507z-yy2xxxxSTWR	Cordless, triggered RS507 with standard battery	✓			✓	✓
RS507z-yy2xxxxSNWR	Cordless, triggerless RS507 with standard battery	✓				✓
RS507z-yy2xxxxENWR	Cordless, triggerless RS507 with extended battery.		✓			✓
RS507z-yy2xxxxCTWR	Corded and triggered RS507			✓	✓	✓
RS507z-yy2xxxx0TWR	Cordless, triggered RS507 with no battery				✓	✓

- **Standard Range (SR):** The SR focusing is used to maximize the far reading distance and is the standard offering on all mobile computing products using same imager. The SR focusing is not specified to read 5 mil code 128 or 6.6 mil Databar and is thus inadequate for applications that have these somewhat higher density reading requirements. This is the default configuration and the configuration of choice where the far reading range is more important than the ability to read high density symbols.

- **Driver License (DL):** The DL focusing is optimized for reading all drivers license and is also specified to read higher density codes such as 5 mil code 128 and Databar and 5 Mil PDF417. As a result it has a slightly reduced range on EAN/UPC codes (typically 12" on photographic quality symbol). This is the preferred configuration where the ability to read these higher density codes is more important than range on medium or low density codes (10 mil and above). DL is recommended in electronics, pharmacy or when handling small items.

Inspect the equipment for damage. If you are missing any equipment or if you find any damaged equipment, contact the Zebra Support immediately. See [Service Information on page 14](#) for contact information.

Cordless Configuration Features

Figure 1 RS507 Cordless Configuration Features

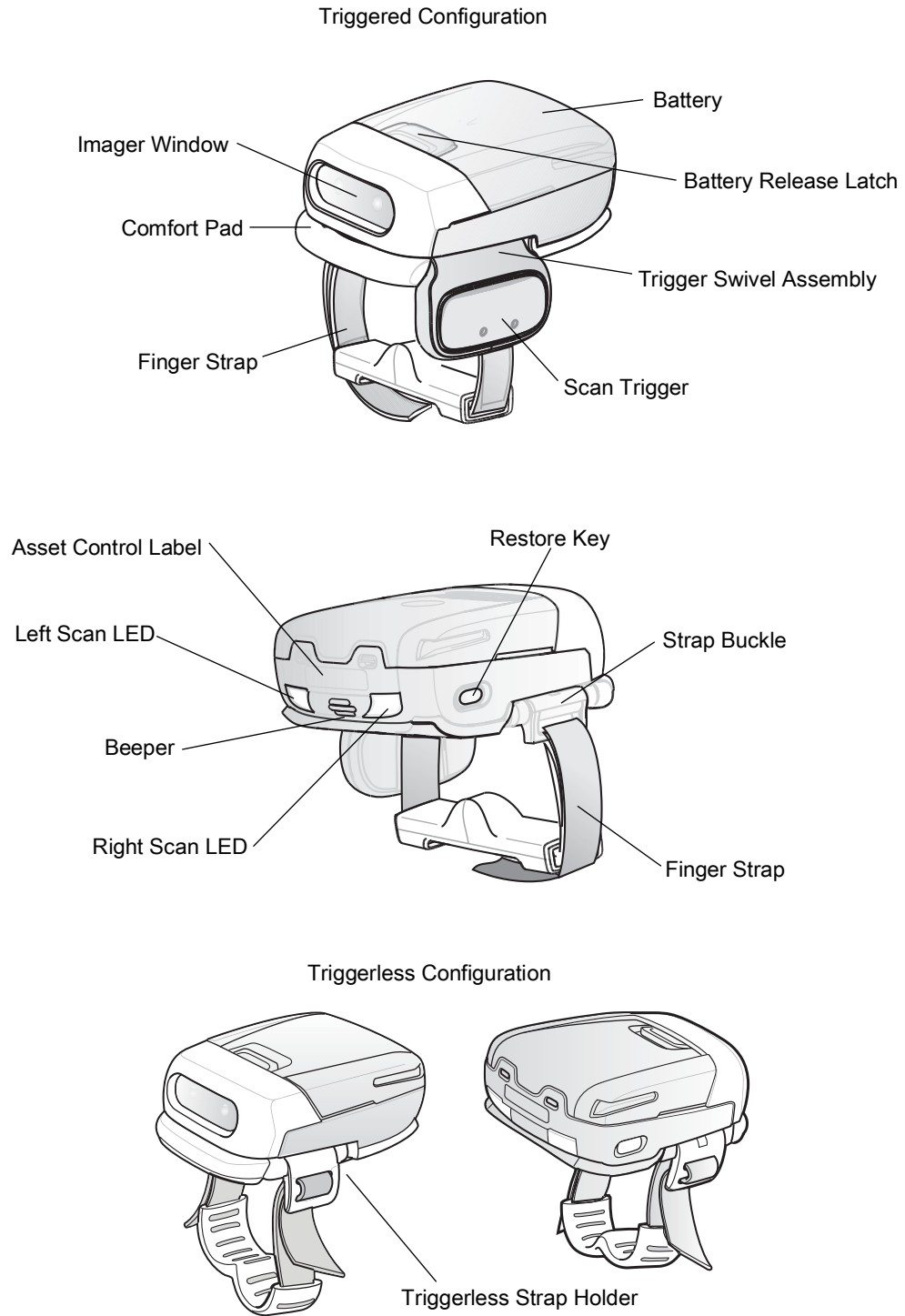

Corded Configuration Features

Figure 2 RS507 Corded Configuration Features

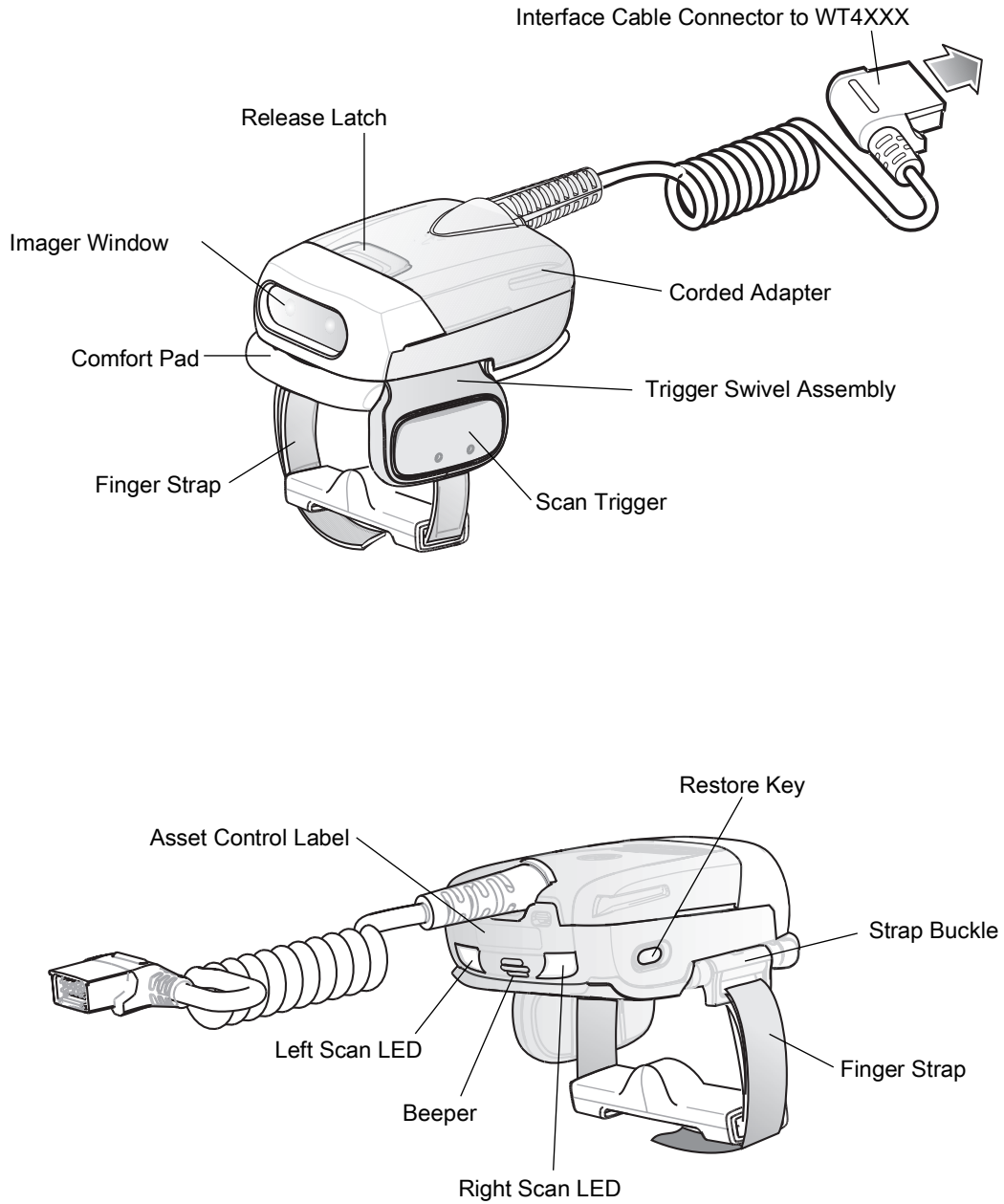

Trigger Swivel Assembly - Change Trigger Position

The Imager is worn on the index and middle fingers, and triggered with the thumb. The Trigger Swivel Assembly of the Imager rotates to provide left-hand or right-hand use.

To change the position of the Trigger:

1. From the bottom of Imager, hold and pull the Comfort Pad off the Imager.

✓ **NOTE:** When removing the Comfort Pad off the Imager, It is not necessary to remove the Finger Strap from the Trigger Swivel Assembly.

Figure 3 Change Trigger Position - Release Finger Strap from Buckle and Remove Comfort Pad

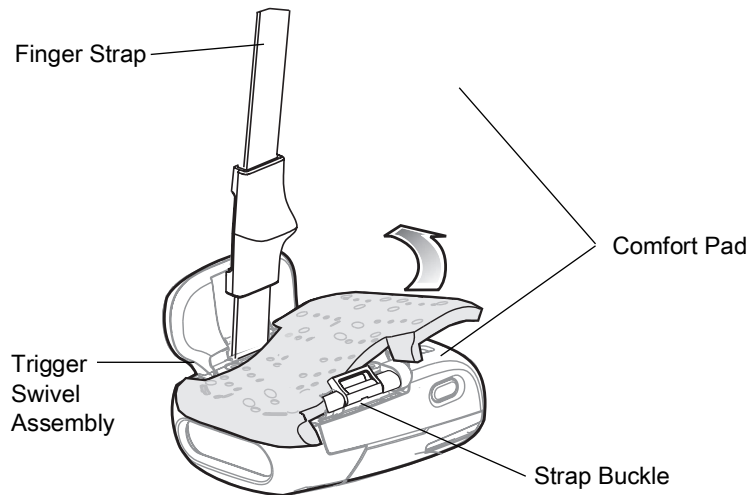

2. Determine whether the Imager is used on the right or left hand and rotate the Trigger Swivel Assembly.

Figure 4 Change Trigger Swivel Assembly Position

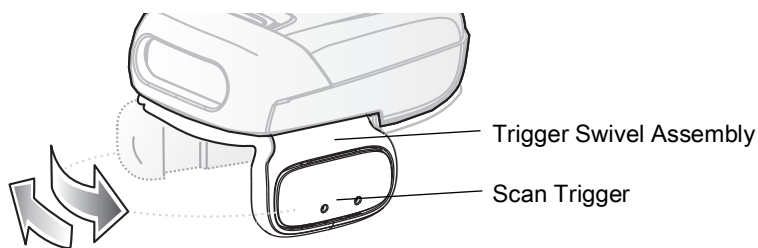

CAUTION: The Trigger Swivel Assembly only rotates 180° around the front of the scan assembly. Do not rotate the Trigger Swivel Assembly past the designed stops.

3. Rotate the Trigger Swivel Assembly so that the Scan Trigger is positioned next to the thumb when the Imager is placed on the index and middle fingers.
4. Position the Comfort Pad onto the Imager.
5. Press the Comfort Pad onto the Imager. When properly installed, the Comfort Pad locks into place.
6. Insert the Finger Strap into the Strap Buckle.

Getting Started - Cordless Configuration

Charge the Battery

Before using the Imager, charge the battery. The SAC5070 8-Bay Battery Charger supports both standard and extended capacity batteries.

To charge the Imager battery, refer to the SAC5070 8-Bay Battery Charger Quick Reference Guide, p/n 72-115989-01 available at: www.zebra.com/support and search for 'SAC5070'.

Install the Battery

1. Align the battery on top of the Imager.
2. Push the battery all the way into the Locking Slots of the Imager.
3. Firmly press the battery into the Imager until a “click” is heard ensuring the Battery Release Latch is fully engaged with the Imager.

Figure 5 Install the Battery

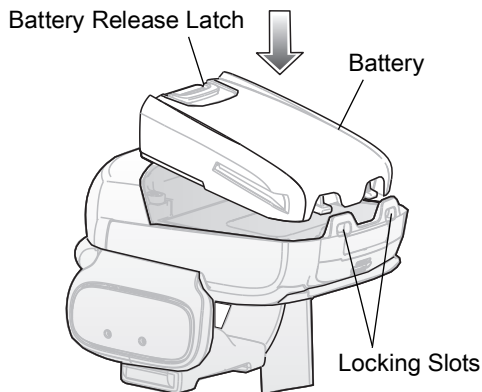

Remove the Battery

1. Hold the Imager in one hand.
2. Press the Battery Release Latch.
3. Pull up the battery to release it from the Locking Slots of the Imager.

Wearing the Imager

1. Slide the Imager onto the index and middle fingers with the Scan Trigger next to the thumb.

Figure 6 Wearing the Imager - Corded Configuration

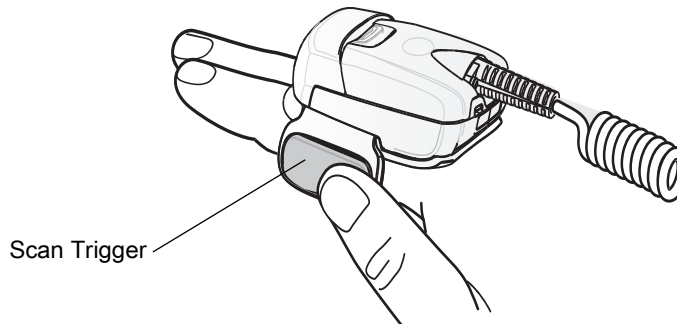

2. Tighten the Finger Strap until it is snug, but not too tight.



CAUTION: To prevent user discomfort, wear the imager snug against the base of the index and middle finger. Do not over tighten.

Figure 7 Wearing the Imager - Cordless Configuration

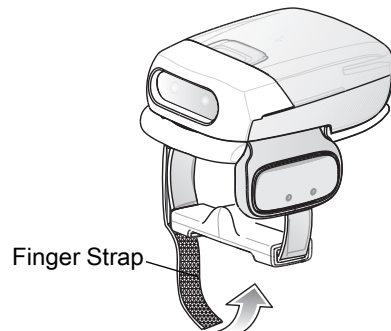

NOTE: When using the Imager for the first time, press and release the Scan Trigger to enable the manual triggering mode (this operation disables the default auto triggering mode).

Getting Started - Corded Configuration

In order to start using the Imager you must install the Corded Adapter.

Connect the Corded Adapter

To connect the Corded Adapter:

1. Align the Corded Adapter on top of the Imager.
2. Support the bottom side of the Imager and push the Corded Adapter all the way into the Locking Slots of the Imager.
3. Firmly press the Corded Adapter into the Imager until a click is heard ensuring the Adapter Release Latch is fully engaged with the Imager.

Figure 8 Connect Corded Adapter

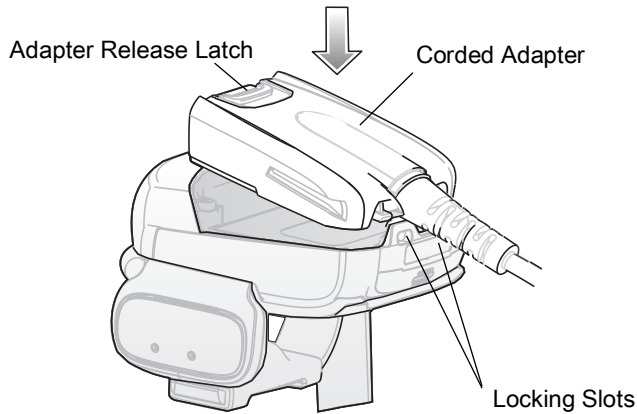

Remove the Corded Adapter

To remove the Corded Adapter:

1. Hold the Imager in one hand.
2. Press the Adapter Release Latch.
3. Pull up the Corded Adapter to release it from the Locking Slots of the Imager.

Connect to a WT4XXX Wearable Terminal

The Imager connects to the Wearable Terminal and mounts on the fingers.

Figure 9 Connecting and Disconnecting to a Wearable Terminal

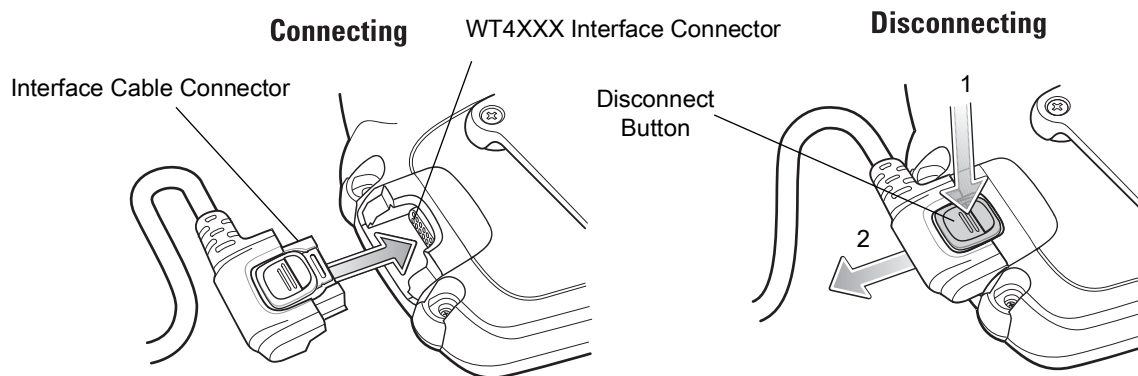

To connect the Imager to the terminal:

1. On the terminal, remove the cover from the WT4XXX Interface Connector.
2. Connect the Interface Cable Connector of the Imager to the WT4XXX Interface Connector.

To disconnect the Imager from the terminal:

1. Press the Disconnect Button on the Interface Cable Connector.
2. Pull the Interface Cable Connector out of the WT4XXX Interface Connector.

Wearing the Imager

To wear the Imager:

1. Slide the Imager onto the index and middle fingers with the Scan Trigger next to the thumb (see [Figure 10](#)).

Figure 10 Wear the Imager - Corded Adapter

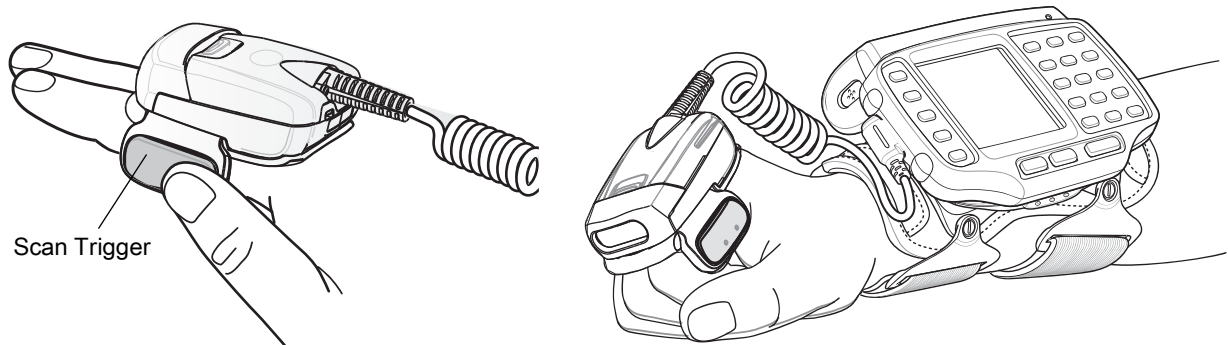

2. Tighten the Finger Strap.

Figure 11 Wear the Corded Adapter Imager - Finger Strap

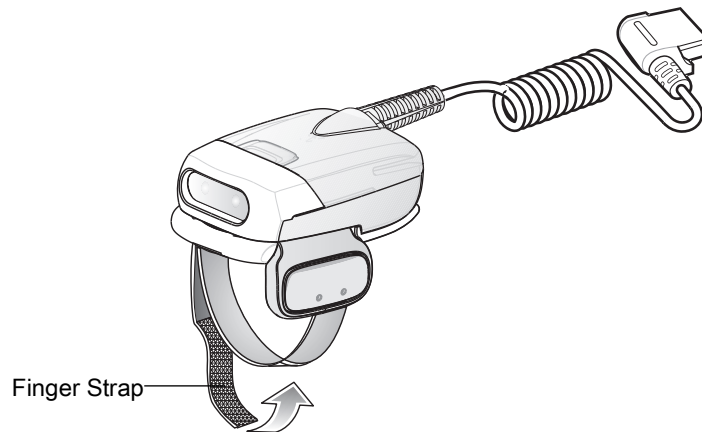

NOTE: When using the Imager for the first time, press and release the Scan Trigger to enable the manual triggering mode (this operation disables the default auto triggering mode).

Status Indications

The Imager has two Scan LEDs that provide identical indications. The Imager is also equipped with a beeper that issues different beep sequences and patterns to indicate status.

Table 2 defines the LED and beep sequences indications that occur during normal operation and bar code scanning.

Table 2 Status Indications

No.	LED	Beep Indication	Description
1.	None	High/low	Bluetooth communication is disconnected due to: <ul style="list-style-type: none"> • host device is powered off. • host device Bluetooth is off. • Bluetooth un-pair bar code scanned by the RS507. • Bluetooth Disconnect bar code scanned by the RS507. • RS507 is out of Bluetooth range with the host device.
2.	Short green flashes	None	Attempting to connect over Bluetooth.
3.	None	Low/high	Imager is connected over Bluetooth.
4.	None	High/low/high/low	Properly decoded scan of Bluetooth pairing bar code.
5.	None	Long low/ long high/	Bluetooth connection attempt failed. If there is no acknowledgment from the host device. Example: Bluetooth on the host device is off.
6.	None	Long low/ long high/ Long low/ long high/	Bluetooth connection attempt is rejected. When the RS507 tries to connect to the host and the host rejects the connection. Example: There is already a successful Bluetooth connection in the host device and it unable to create a new connection.
7.	One green flash	High	Proper scanning indication.
8.	None	4 long beeps	No Bluetooth communication after re-connection failure.
9.	Red flash	2 short beeps every 15 seconds	Low battery.
10.	Long red flash followed by a green flash	High/low High/low	Clean Boot was performed successfully.



NOTE: When the Imager is connected by corded configuration, only “Proper scanning indication” and “Clean Boot was perform successfully” status events are indicated.

Imager Standby Mode

To save battery power, the Imager goes into Standby when not active.

The Imager resumes functionality when:

- Bluetooth data is received from the mobile computer (in cordless configuration)
- Scan trigger is pressed
- Restore key is pressed
- Motion is detected (in cordless configuration)
- Incoming data from mobile computer is sensed (in corded configuration).

Bluetooth Connection

Establish Bluetooth Connection

To establish Bluetooth connection with a mobile computer:

1. Ensure that the Imager is within a range of 10 meters (30 feet) from the mobile computer.
2. Install the battery in the Imager.
3. Launch the Bluetooth Device (BD) address application (see [Figure 12](#)) from the mobile computer. Most BD Address applications display a pairing bar code image on the screen of the mobile computer.



NOTE: To find the BD address application tap the **Start** button and select Programs > Display_BD_Address or **Start** > Programs > BT Information and then tap the **Generate Local BD Address Barcode** button to display the BD address bar code.

Figure 12 Icon of Bluetooth Device (BD) Address Application

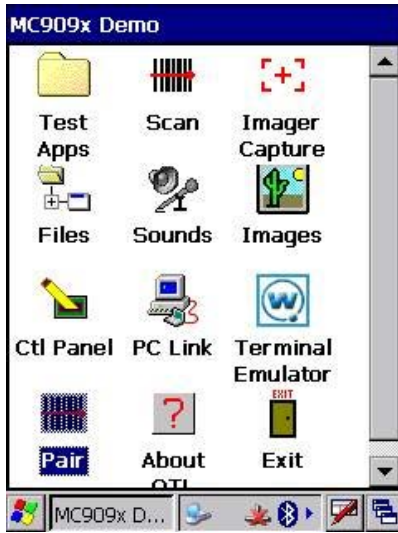

Bluetooth Device (BD) address icon on MC909X Demo screen



Bluetooth Device (BD) address icon on Windows Mobile Programs screen

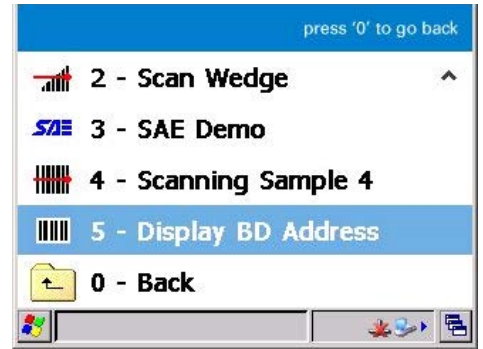

Bluetooth Device (BD) address icon on WT4XXXApplication screen

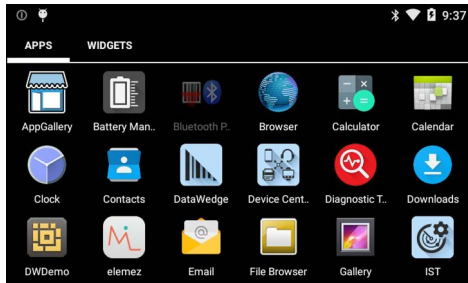

Bluetooth pairing application for WT6000



BTUI pairing application for WT41N0

4. Scan the pairing bar code on the mobile computer screen (see Figure 13) or a provided pairing label. When scanning, the Imager emits one string of high/low/high/low beeps.

✓ **NOTE:** To create printed pairing bar code label, refer to [Pairing Bar Code Format on page 28](#).

Figure 13 Pairing Bar Code Example as Shown on the Mobile Computer Screen



5. The Scan LED starts flashing green indicating that the Imager is attempting to establish connection with a mobile computer.
 - ✓ **NOTE:** If the Imager default PIN code is required for establishing connection, enter the following code: "12345". You may also need to set the authentication and encryption to Enabled.
6. When connection is established, the Scan LED turns off and the Imager emits one string of low/high beeps. The Imager is connected and ready for scanning.
 - ✓ **NOTE:** When replacing the Imager battery, the Imager memory retains the pairing information of the last paired mobile computer.

Restore Lost Bluetooth Connection

The Imager maintains Bluetooth communication with a mobile computer within a range of 10 meters (30 feet). When the Imager fails to establish connection or connection is lost during operation, the Imager emits one string of high/low beeps.

To reestablish the Bluetooth connection with a mobile computer:

1. Ensure that the Imager is within a range of 10 meters (30 feet) from the mobile computer.
2. Ensure that the mobile computer is on and "awake" (not in Suspend mode).
3. The Imager automatically attempts reconnecting to the mobile computer for 30 seconds (Scan LED flashes green). If automatic re-connection fails, verify that the Imager is within Bluetooth range and briefly press the Restore Key on the Imager to reconnect.
 - ✓ **NOTE:** You can also reconnect by scanning a pairing bar code from the mobile computer screen or provided label. When scanning, the Imager emits one string of high/low/high/low beeps.
4. The Scan LED starts flashing green indicating that the Imager is attempting to establish connection with a mobile computer. The Scan LED turns off and the Imager emits one string of low/high beeps indicating that the Imager is connected and ready for scanning.

Remove Bluetooth Connection

Remove Bluetooth connection to allow the Imager to connect to another mobile computer or to enable the a mobile computer to accept the connection from another Imager.

- ✓ **NOTE:** Removing Bluetooth connection is only required if the Imager is configured to auto-connect upon power-up (permanent pairing is enabled) and has to be paired with a different mobile computer.

To remove Bluetooth connection:

1. Scan an un-pairing bar code for disconnecting the Imager from the mobile computer.

Figure 14 Un-pairing Bar Code



2. The Imager emits one string of high/low beeps indicating that Bluetooth communication with the mobile computer is disconnected.

Pairing Bar Code Format

In order to pair the Imager with a mobile computer over Bluetooth, a pairing bar code must be created. You can use the Display_BD_Address application on the mobile computer, or create and print a pairing bar code label. To create a pairing bar code label, the Bluetooth address of the mobile computer should be available (refer to the mobile computer user guide).

Pairing bar codes are Code 128, Data Matrix or Aztec symbologies formatted as follows:

<Fnc3>Bxxxxxxxxxxxx

Where xxxxxxxxxxxx represents the 12-character Bluetooth address.

Pairing Bar Code Example

If the mobile computer to which the Imager connects has a Bluetooth address of 11:22:33:44:55:66, then the pairing bar code is:

Figure 15 Creating a Pairing Bluetooth Bar Code



Pairing Bar Code Content: <Fnc 3> 'B' + Bluetooth Address

Scan

The Imager uses digital camera technology to take an image of a bar code and software decoding algorithms are executed to extract the bar code data from the image.

Scan Triggering Modes

Manual Triggering (Triggered models only)

1. Launch a scanning software application on the mobile computer.
2. Position the Imager approximately 22.8 cm (9 inches) from a bar code and press the Scan Trigger. Position the cross hair laser beam to cover the bar code. The Imager takes a digital picture (image) of the bar code and stores it in memory for decoding.

✓ **NOTE:** After battery is inserted or a corded adaptor is connected (on both sides), the first trigger press disables the auto triggering mode.

3. One green flash of the LEDs is given and a high beep sounds to indicate that the bar code was properly decoded.

✓ **NOTE:** In some configurations proper decoding of a bar code is indicated by the software application running on the mobile computer.

Auto-triggering (Triggerless models only)

The Imager is provided with auto-triggering capability. In auto-triggering mode, both motion and proximity sensors are used to trigger the Imager when the user intends to scan a bar code.

With auto-triggering activated, the Imager automatically scans when motion stops and a bar code is placed within the depth of field of the Imager. The Imager scans the bar code and turns off to conserve power.

To scan a bar code in auto-triggering mode:

1. Position the Imager approximately 22.8 cm (9 inches) from a bar code.
2. Aim at the bar code.
3. The Imager takes a picture (image) of the bar code and stores it in memory for decoding.
4. One green flash of the Scan LEDs and a high beep indicates that a bar code was properly decoded.

✓ **NOTE:** In some applications, proper detection of a bar code is indicated by a software application running on the mobile computer.

Aiming the Imager

The aiming pattern of the Imager is a cross hair laser beam with bright center dot (see [Figure 16](#)). The virtual rectangle made by the cross hair reflects the field of view of the Imager. The aiming pattern is used to position the bar code within the field of view.

Figure 16 Cross Hair Laser Beam

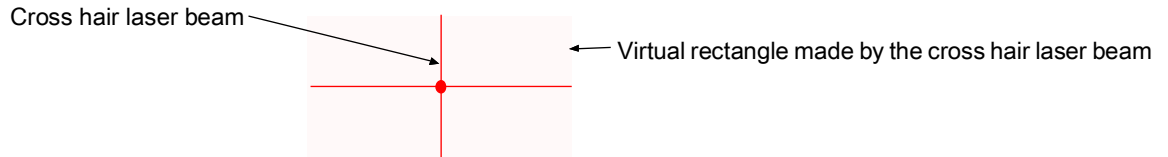

Enter the symbol in any orientation within the virtual rectangle made by the cross hair laser beam, making use of its omnidirectional reading capability within the entire field of view.

Figure 17 Symbol Scan Orientation

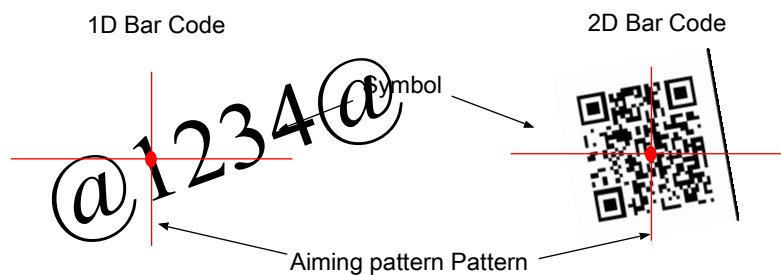

The Imager can also read a bar code presented within the aiming pattern but not centered (see the top bar codes on [Figure 18](#)). The bar codes marked with X in [Figure 18](#), however, show bar code aiming that may result in no decode.

When using the application on your mobile computer in “Pick List” mode, the Bright Center Dot can be positioned anywhere on the symbol (see [Figure 16](#)). The top examples in [Figure 18](#) show acceptable aiming options, while the bottom examples can not be decoded.

Figure 18 Acceptable Aiming Options

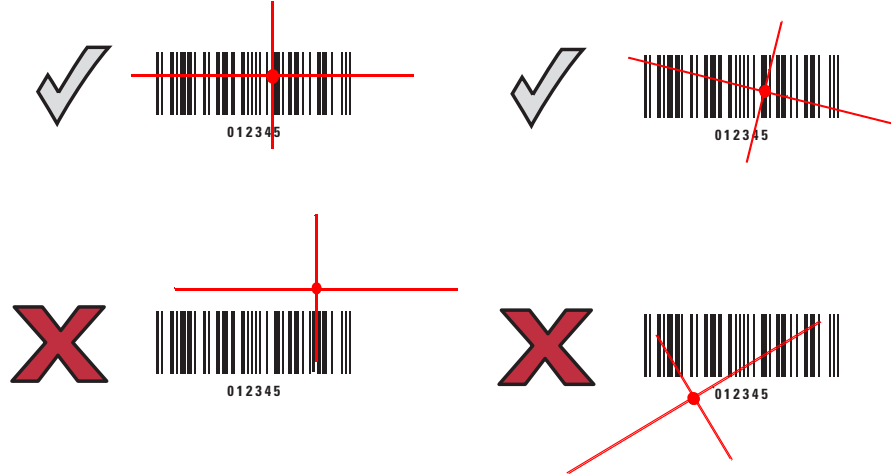

The aiming pattern is smaller when the Imager is closer to the symbol and larger when it is farther from the symbol. Scan symbols with smaller bars or elements (mil size) closer to the Imager and those with larger bars or elements (mil size) farther from the Imager.

1. Hold the Imager between two and eleven inches from the bar code (depending on the bar code density).

✓ **NOTE:** When a symbol is under transparent plastic or on a mobile computer screen, it is recommended to use a tilt (pitch) or skew scan angle to minimize reflection.

2. Press the Scan trigger. The aiming pattern illuminates red indicating that the laser is on. One green flash of the Scan LED and a high beep indicates that a bar code was properly decoded.

Customize the Imager

Changing from Triggered to Triggerless Configuration

To change from Triggerred to Triggerless configuration:

1. Remove the Comfort Pad (see [Comfort Pad Replacement on page 40](#)).
2. Remove the Trigger Swivel Assembly (see [Trigger Swivel Assembly Replacement on page 41](#)).
3. Install the Triggerless Strap Holder (see [Triggerless Strap Holder Replacement on page 42](#)).
4. Install the Comfort Pad (see [Comfort Pad Replacement on page 40](#)).
5. Perform a cold boot (see [Cold Boot on page 31](#)).

Changing Triggerless to Triggered Configuration

To change from Triggerless to Triggerred configuration:

1. Remove the Comfort Pad (see [Comfort Pad Replacement on page 40](#)).
2. Remove the Triggerless Strap Holder (see [Triggerless Strap Holder Replacement on page 42](#)).
3. Install the Trigger Swivel Assembly (see [Trigger Swivel Assembly Replacement on page 41](#)).
4. Install the Comfort Pad (see [Comfort Pad Replacement on page 40](#)).
5. Perform a cold boot (see [Cold Boot on page 31](#)).

6. Press and release the Scan Trigger to enable the manual triggering mode (this operation disables the default Triggerless mode).

Resetting the Imager

If the Imager stops responding to input, reset it. There are three reset functions, warm boot, cold boot and clean boot. Perform a warm boot first. If the Imager still does not respond, perform a cold boot. Perform clean boot to restore the Imager to its factory default configuration.

Warm Boot

To perform warm boot, press and hold the Restore Key for more than six seconds.

Cold Boot

Cold boot restores the Imager's operation by resetting its software. To perform cold boot, remove and re-insert the battery into the Imager. When using a corded Imager model with WT4XXX, remove and reconnect the interface cable that connects between the Imager and the WT4XXX.

Clean Boot

Clean Boot restores the Imager to its factory default configuration.

To perform clean boot:

1. Remove battery or disconnect the Corded Adapter.
2. Press and hold the Restore Key.
3. Insert the battery or Corded Adapter into the Imager.
4. Continue to press and hold the Restore Key for about five seconds until a chirp is heard and the Scan LEDs flash green. The Imager is now in its factory default configuration.

✓ **NOTE:** The factory default configuration is set in the factory or the service center. These parameters are unique for each Imager and cannot be changed. The Factory default configuration includes: Imager serial number, Bluetooth Device (BD) address, model number, production date and proximity calibration.

SAC5070 8-Bay Battery Charger

Introduction

The SAC5070 8-Bay Battery Charger is an accessory for the RS507/RS507X Hands-free Imager and provides a quick way to recharge the Lithium-ion battery that provide power for the RS507/RS507X Hands-Free Imager. One charger can hold up to eight batteries at a time.

The 8-Bay Battery Charger supports both standard and extended capacity batteries. The Charger may only be used indoors.

Unpacking the Charger

After opening the shipping box, inspect the contents. You should have received the following:

Model	Description	8-Bay Battery Charger	Power supply	AC Line Cord	Quick Start Guide
SAC5070-800CR	USA model	x	x	x	x
SAC5070-801CR	International model	x	x	*	x

* For AC line cord, contact the Zebra representative in your country.

Inspect the equipment for damage. If you are missing any equipment or if you find any damaged equipment, contact Zebra Support immediately.

Parts of the Charger

Figure 19 Parts of the Charger

Charger Front

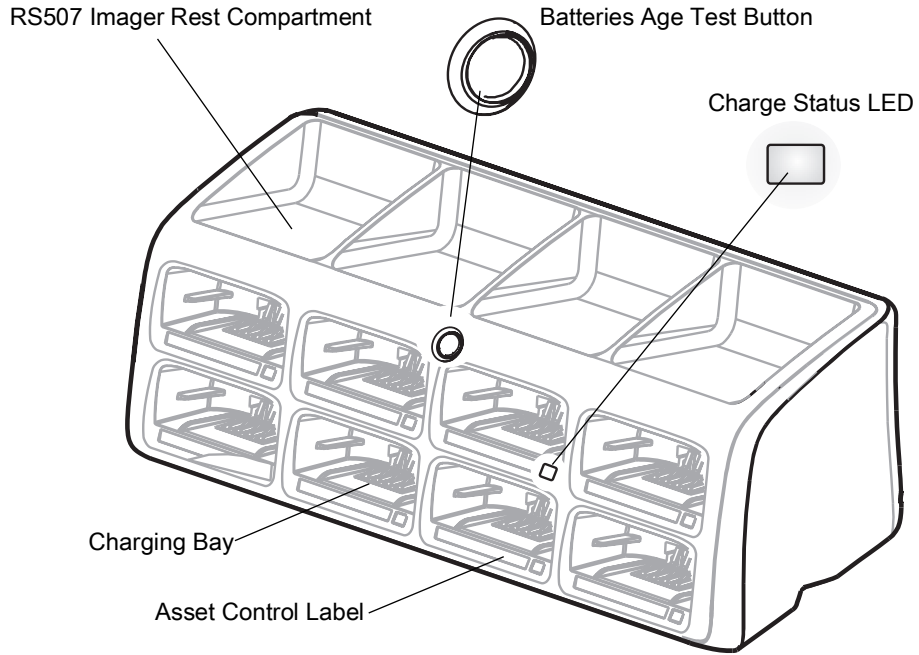

Charger Back

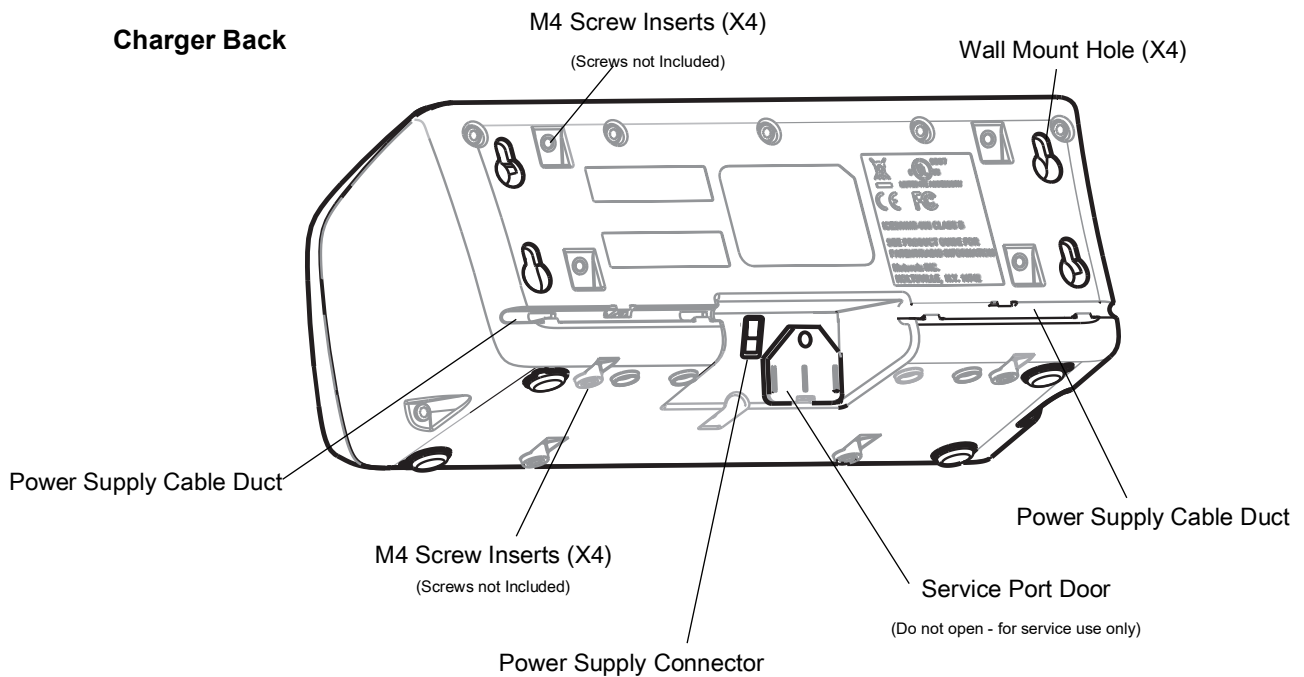

Installation

Tabletop / Shelf Set Up

To set the Charger on a tabletop or shelf:

1. Place the Charger and the Power Supply Unit on a tabletop or shelf.

✓ **NOTE:** When required, use the screw inserts at the back and base to secure the Charger to the tabletop or shelf surface.

2. Connect the Power Supply Cable to the power connector on the back of the Charger.
3. Use the Power Supply Cable Duct, on the back of the Charger, to route the Power Supply Cable to the left or right side of the Charger.
4. Connect the AC plug of the AC Power Cord to a standard electrical outlet.

Figure 20 Charger Installation

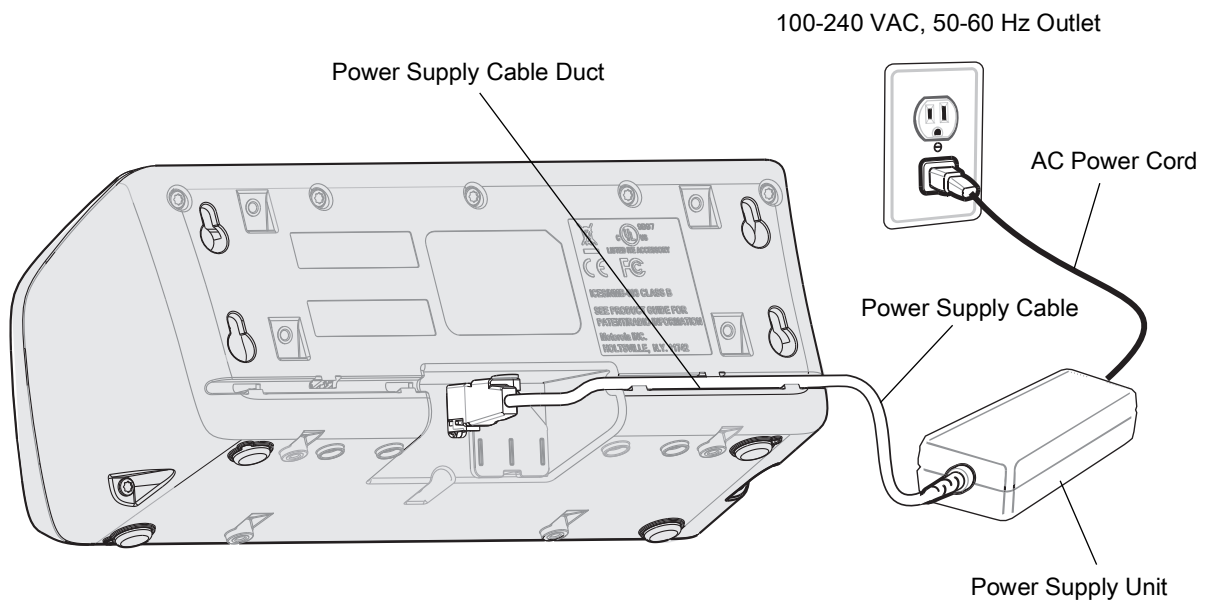

Wall Mount



WARNING: For safe mounting, it is essential to use wall anchors appropriate to the wall type (i.e. plaster, drywall, concrete, etc.). Mount to wood studs whenever possible.

To mount the Charger on a wall:

1. Mark the screw location on the wall.

2. Use four screws to mount the Charger to a wall. Be sure to use additional wall mounting hardware, as needed, for safe mounting according to the wall type.
3. Connect the power supply cable to the power connector on the back of the Charger (see [Figure 21](#)).
4. Use the Power Supply Cable Duct, on the back of the Charger, to route the Power Supply Cable to the left or right side of the Charger.
5. Place the Power Supply Unit on a shelf or tabletop.
6. Connect the AC plug of the AC Power Cord to a standard electrical outlet.

Figure 21 Wall Mounting of Charger

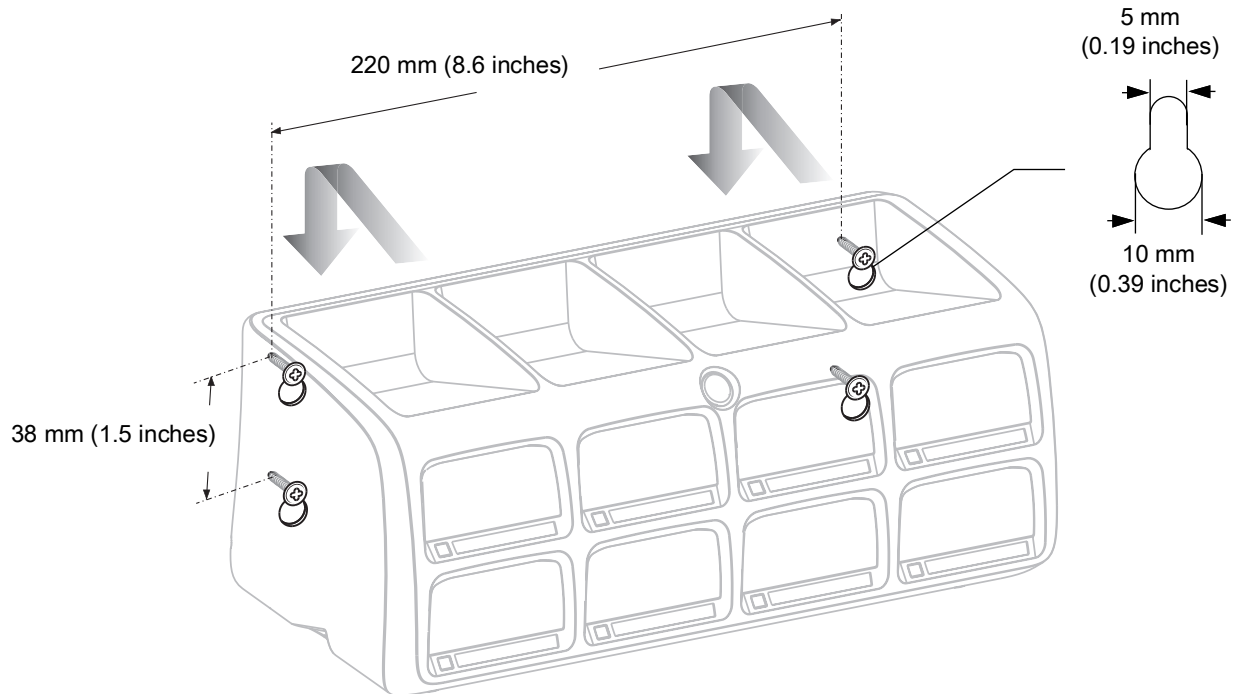

Inserting the Imager Battery in the Charger

The Charger supports both standard and extended capacity batteries.

Figure 22 Inserting the Imager Battery into the Charger

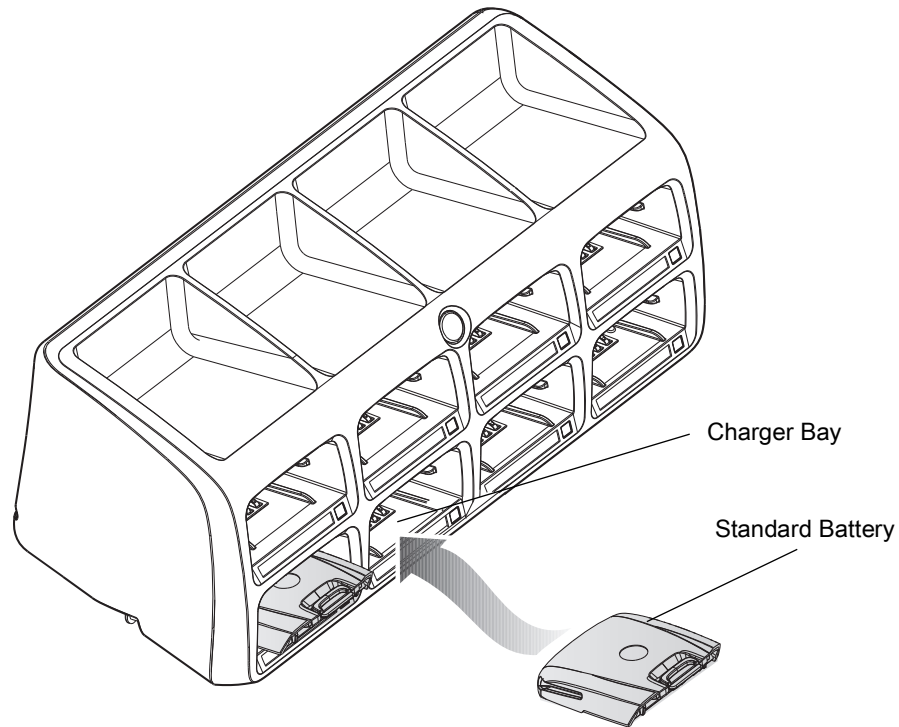

Charge the Battery



CAUTION: Only Lithium-ion batteries that have been designed for use with the RS507 Hands-free Imager can be recharged by the Charger. Do not attempt to recharge other types of rechargeable batteries or any type of batteries. Doing so could destroy those batteries and damage the Charger.



NOTE: Batteries should be charged within the 0°C (+32°F) and +40°C (+104°F) ambient temperature range.

To charge the battery(s):

1. Insert the battery(s) into the 8-Bay Battery Charger so that the contacts of the battery are first to enter, facing down, gently. Do not use excessive force.
2. The 8-Bay Battery Charger starts to charge automatically. On each bay, the flashing amber Charge Status LED (see [Figure 19](#)) indicates the charge status.

A full charge of a depleted battery takes up to four hours. The Charge Status LED lights solid amber when the battery is fully charged.

Battery Age Test

The battery age test checks the battery capacity when fully charged. A worn-out battery is considered to have less than 80% of its nominal capacity. The battery test is simultaneously performed for all batteries inserted into the charger. It is recommended to perform battery age testing once a month. The age test may take up to 16 hours.



NOTE: A battery removed during test and re-inserted is excluded from the test but continues normal charging.

To test the battery(s):

1. Insert one or more batteries into Charging Bay(s).
2. Press and hold the Test Button for approximately 3 seconds until the Charge Status LED of each active bay flashes green.
3. Refer to the table below when the indication of the Charge Status LED changes.

Charge Status LED

The Charge Status LEDs show the charge status of each Charging Bay:

Table 3 Charge LED - Status Indications

LED Indication	Status
Flashing amber	Charging in progress.
Solid amber	Charging is completed.
Flashing green	Battery age testing in progress.
Flashing red/green	Defective battery or error in charging; re-insert the battery into the bay.
Solid green	Battery age test and charge are completed. Battery is good.
Solid red	Battery age test and charge are completed. Battery capacity is marginal.
Flashing red	Battery age test and charge are completed. Battery is worn out.

Troubleshooting & Maintenance

Introduction

This chapter provides suggested Imager and Charger troubleshooting and maintenance.

Troubleshooting

Imager

Table 4 Imager Troubleshooting

Problem	Cause	Solution
Laser aiming pattern does not display when pressing the Scan Trigger.	Corded: Interface cable is not secure.	Verify that the interface cable is properly connected.
	Cordless: Battery is not charged.	Replace or charge battery.
	Power is not applied to Imager.	Corded: Verify that the mobile computer has a fully charged battery installed. Cordless: Replace or charge Imager battery.
	Scan application on the mobile computer is not functioning.	Restart the scanning application on the mobile computer.
	Imager does not respond.	Reset the Imager (See Resetting the Imager on page 31).

Table 4 Imager Troubleshooting

Problem	Cause	Solution
Imager does not decode a bar code.	Bar code is unreadable.	Verify that the bar code is not defective, i.e., smudged or damaged.
	Exit window is dirty.	Clean exit window with a lens tissue. Tissues for eyeglasses work well. Do not use tissues coated with lotion (see Cleaning the Imager on page 46).
	Bar code symbology is not supported or enabled.	See your system administrator.
	Cordless: Bluetooth link is disconnected.	Reestablish Bluetooth connection (See Establish Bluetooth Connection on page 25).

✓ **NOTE:** If after performing these checks the Imager still experiences problems, contact the distributor or call Zebra Support. See [Service Information on page 14](#).

Charger

Table 5 Charger Troubleshooting

Problem	Solution
The Power LED does not light	Make sure the Power plug of the Power Supply Unit is plugged into a wall outlet and the connector on the end of the Power Supply Cable is plugged into the Charger's power connector.
	Plug the Power plug of the Power Supply Unit into another outlet.
	Replace the Power Supply Unit.
	Contact a service representative (see Service Information on page 14).
The battery takes too long to recharge	Ensure that room/battery temperatures are within charging range 0 °C to +40 °C (+32 °F to +104 °F).
	Clean the contacts on the battery (see Cleaning the Charger on page 47).
	Try another battery to make sure the Charger functions properly. (If the charge time is more than four hours the Charge Status LED flashes red/green.)
	Contact a service representative (see Service Information on page 14).
LED indication continuously changes from red to green	Remove and re-insert the battery into the charging bay.
	Check for dirt on battery charging contacts and/or charging bay contacts (see Cleaning the Charger on page 47).
	Replace battery with a new one.
	Contact a service representative (see Service Information on page 14).

Maintenance

Cleaning the scan window is the basic maintenance required. A dirty window can affect scanning accuracy.

- Do not allow abrasive material to touch the window.
- Remove any dirt particles with a damp cloth.
- Wipe the window using a tissue moistened with ammonia/water.
- Do not spray water or other cleaning liquids directly into the window.

Maintaining the Imager

Comfort Pad Replacement

Removal

To remove the Comfort Pad:

1. Flip the Imager over, such that the bottom of the Imager and the Comfort Pad are facing upwards.
2. On a Triggerless Swivel Assembly, remove the M2 screw.
3. Insert the tip of your finger under the edge of the Comfort Pad at the back of the Imager.
4. Lift the Comfort Pad upwards and remove it from the Imager.



CAUTION: Removing the Comfort Pad other than the described above may result in damage to the Trigger Swivel Assembly of the Imager.



NOTE: It is not necessary to remove the Finger Strap from the Trigger Swivel Assembly.

Figure 23 Removal of Comfort Pad

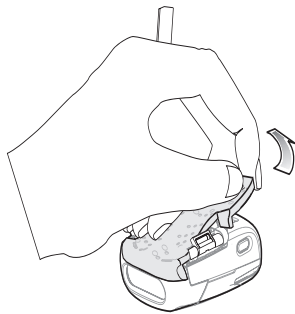

Trigger Swivel Assembly

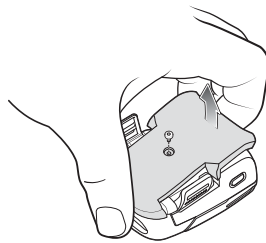

Triggerless Strap Holder

Installation

- ✓ **NOTE:** Only use a Trigger Comfort Pad on a Trigger Swivel Assembly. To install the Triggerless Comfort Pad on a Trigger Swivel Assembly, do not use the M2 screw.

To install the Comfort Pad:

1. Position the Comfort Pad onto the Imager as shown.

Figure 24 Installation of Comfort Pad

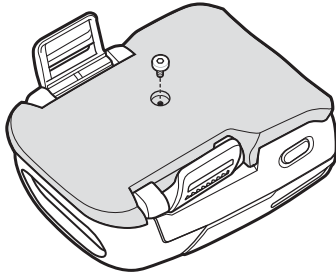

2. Press the Comfort Pad onto the Imager. When properly installed, the Comfort Pad locks into place.
3. On a Triggerless Swivel Assembly, install the M2 screw.

Trigger Swivel Assembly Replacement

Removal

To remove the Trigger Swivel Assembly:

1. Turn the Imager upside-down.
2. Remove the Comfort Pad.
3. Use a paper clip or similar object to press the Release Latch.

Figure 25 Removal of Trigger Swivel Assembly

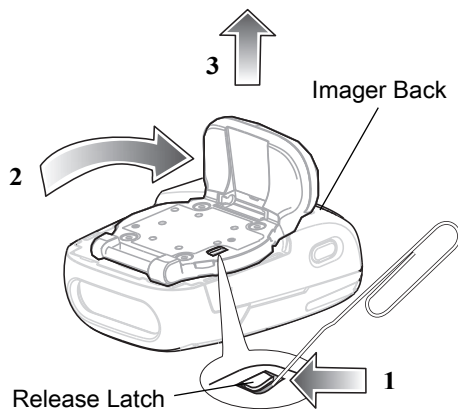

4. Rotate the Trigger Swivel Assembly to align with the back of the Imager.
5. Lift the Trigger Swivel Assembly off the scan assembly.

Installation

To install the Trigger Swivel Assembly:

1. Turn the Imager upside-down.
2. Position the Trigger Swivel Assembly to align with the back of the Imager.
3. Lower the Trigger Swivel Assembly onto the scan assembly.

Figure 26 Installation of Trigger Swivel Assembly

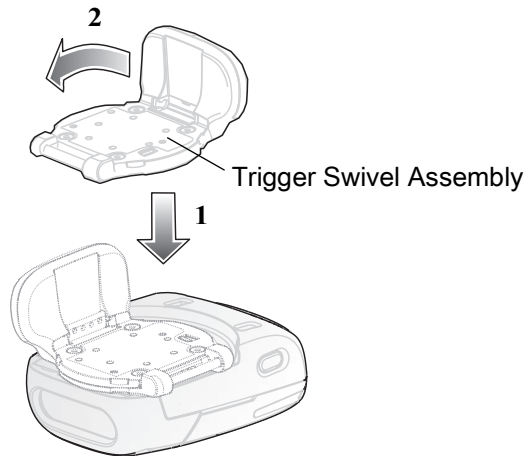

1. Rotate the Trigger Swivel Assembly 1/4 turn counterclockwise.
2. Press the Comfort Pad onto the Imager. When properly installed, the Comfort Pad locks into place.

Triggerless Strap Holder Replacement

- ✓ **NOTE:** The Triggerless Strap Holder should be installed when the Imager is intended to be used in Motion and Proximity Initiated bar code read mode.

Removal

To remove the Triggerless Strap Holder:

1. Turn the Imager upside-down.
2. Remove the Comfort Pad.
3. Use a paper clip or similar object to press the Release Latch.

Figure 27 Removal of Triggerless Strap Holder

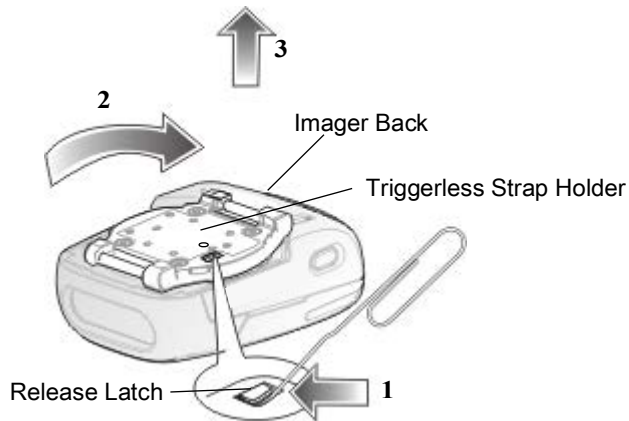

4. Rotate the Triggerless Strap Holder to align with the back of the Imager.
5. Lift the Triggerless Strap Holder off the Imager.

Installation

To install the Triggerless Strap Holder:

1. Turn the Imager upside-down.
2. Position the Triggerless Strap Holder to align with the back of the Imager.

Figure 28 Installation of Triggerless Strap Holder

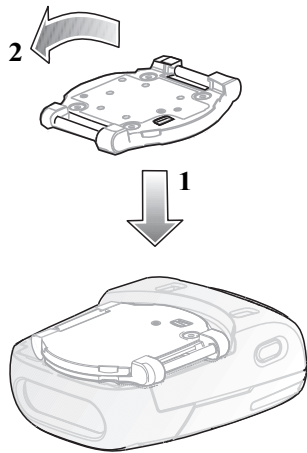

3. Lower the Triggerless Strap Holder onto the Imager.
4. Rotate Triggerless Strap Holder 1/4 turn counterclockwise.

Finger Strap Replacement (Trigger Swivel Assembly)

Removal

1. Remove the Finger Strap from the Strap Buckle.
2. Pull the Finger Strap out of the Trigger Swivel Assembly.

Installation

1. Align a new Finger Strap with the Slots in the Trigger Swivel Assembly.

Figure 29 Finger Strap Replacement (Trigger Swivel Assembly)

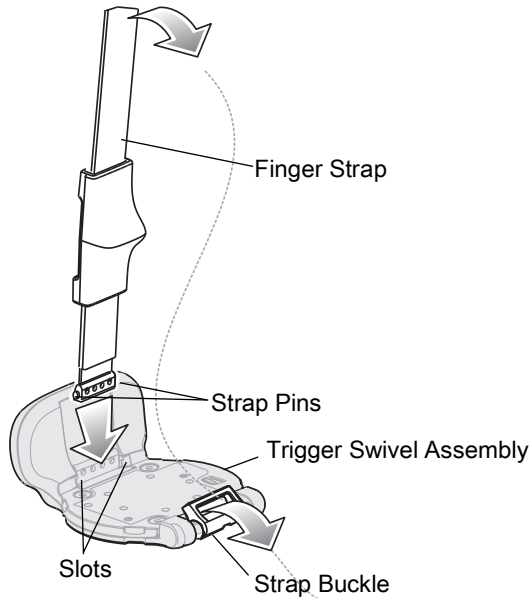

2. Gently press the Strap Pins to engage with the Slots of the Trigger Swivel Assembly. The Strap Pins snap into the slots.
3. Slip the Finger Strap through the Strap Buckle.

Finger Strap Replacement (Triggerless Strap Holder)

Figure 30 Replacement of Finger Strap (Triggerless Strap Holder)

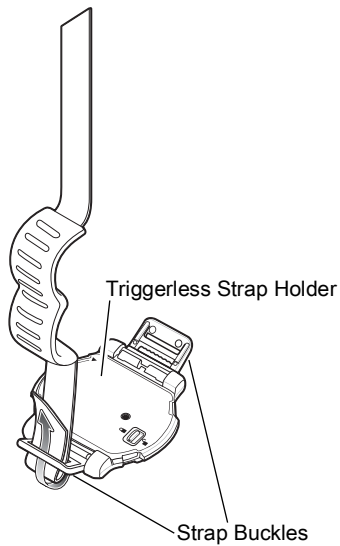

Removal

Remove the Finger Strap from the Strap Buckles.

Installation

Slip the Finger Strap through the Strap Buckles.

Strap Buckle Replacement

Figure 31 Strap Buckle Replacement

Removal

1. Remove the Trigger Swivel Assembly (see [Trigger Swivel Assembly Replacement on page 41](#)).
2. Press the Strap Buckle off the Trigger Swivel Assembly Pin.

Installation

1. Align the pin slot of Strap Buckle with the pin of the Trigger Swivel Assembly.

Figure 32 Strap Buckle Replacement

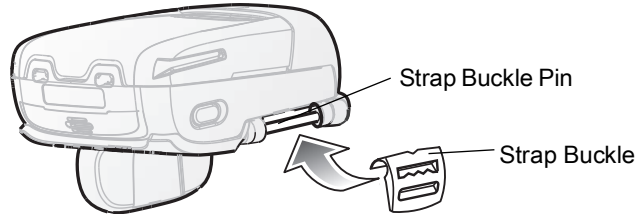

2. Gently press the pin slot of Strap Buckle to engage with the pin of the Trigger Swivel Assembly. The pin slot snaps onto the pin.
3. Install the Trigger Swivel Assembly (see [Trigger Swivel Assembly Replacement on page 41](#)).

Field Replaceable Parts

Table 6 Imager Field Replaceable Parts

No	Part	Description
1	KT-CLMPT-RS507-01R	Trigger Swivel Assembly.
2	KT-BKL-RS507-10R	Set of 10 Buckles for Hook and Loop Strap.
3	KT-BKLN-RS507-10R	Set of 10 Buckles for Triggerless Elastic Finger Strap.
4	KT-BKLT-RS507-10R	Set of 10 Buckles for Trigger Elastic Finger Strap.
5	KT-CLMPN-RS507-01R	Triggerless Strap Holder.
6	KT-PAD-RS507-10R	Set of 10 Trigger Comfort Pads.
7	KT-PAD2-RS507-10R	Set of 10 Triggerless Comfort Pads. M2 Screw Included.
8	KT-STRPN-RS507-10R	Set of 10 Triggerless Finger Strap.
9	KT-STRPT-RS507-10R	Set of 10 Trigger Finger Strap.
10	KT-STRP2-RS507-10R	Set of 10 Trigger or Triggerless Elastic Strap.
11	KTBTRYRS50EAB00-01	Standard Battery.

Table 6 Imager Field Replaceable Parts

No	Part	Description
12	KTBTRYRS50EAB02-01	Extended Battery.
13	ADPTRWT-RS507-04R	Corded Adapter.
	KT-ESTRPTRS507-10R	Set of 10 Elastic Straps with Buckles for Trigger and Triggerless configurations.

Figure 33 Imager Field Replaceable Parts

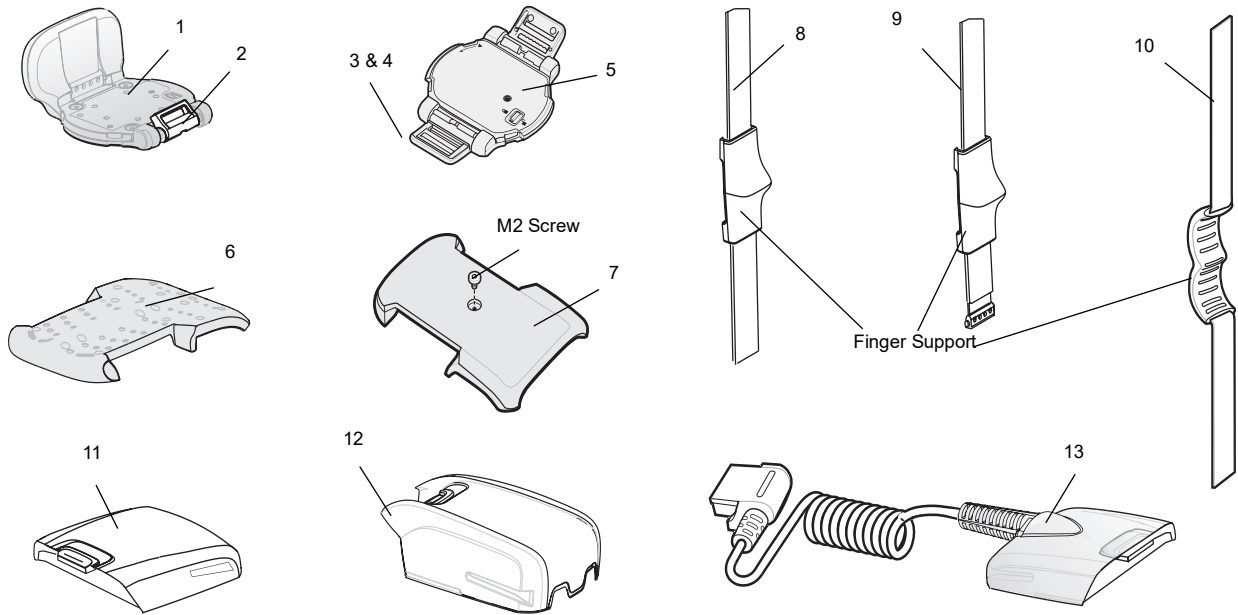

Cleaning the Imager

Wipe the exit window periodically with a lens tissue or other material suitable for cleaning eyeglasses.



CAUTION: Do not pour, spray, or spill any liquid on the Imager.

The gold plated battery contacts do not tarnish or oxidize. No maintenance should be needed. If the contacts need to be cleaned:

1. Wet the tip of a cotton swab with isopropyl alcohol and squeeze the excess alcohol from the swab.
2. Wipe the metal contacts with the damp swab.

Figure 34 Cleaning the Battery

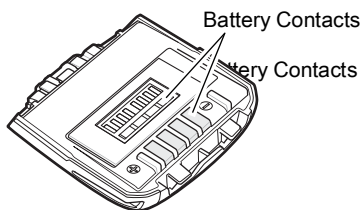

Maintaining the Charger

The Charger is well constructed and durable; however, it is a precision electronic device and must be treated as such.

Follow the procedures in this section to ensure reliable service.

Operating conditions for the Charger

The Charger is designed to operate in environments that are normally free of dust, dirt, and moisture. It can be operated at temperatures between 0°C (+32°F) and +40°C (+104°F).

Handling the Charger

- Do not attempt to open the Charger. No user-serviceable parts are inside.
- Charge only Lithium-ion batteries that have been designed for use with the Imager. Do not attempt to recharge other types of rechargeable batteries or any type of primary batteries.
- Do not place objects other than Imager batteries inside the Charger.
- Protect the Charger from excessive heat, cold, moisture, and harsh, dirty environments.
- Do not leave the Charger where moisture will condense on it.

Cleaning the Charger



CAUTION: Do not pour, spray, or spill any liquid on the Charger.

The gold plated battery contacts do not tarnish or oxidize. No maintenance should be needed. If the contacts need to be cleaned:

1. Remove power from the Charger.
2. Wet the tip of a cotton swab with isopropyl alcohol and squeeze the excess alcohol from the swab.
3. Wipe the metal contacts with the damp swab.

RS507 Update and Configuration

Introduction

This chapter covers the following topics:

- Configuring the Imager
- Imager Motion and Proximity Configuration
- Debugging logger
- Firmware upgrade

Configuring the Imager

Introduction

The Imager is a modular product used in several hardware configurations. Such configurations may include corded or cordless connection to a terminal / mobile computer with manual or automatic triggering.

The Imager is provided with a default software configuration set in the factory. This software configuration can be optimized by the customer to meet their specific operational requirements. Therefore, before using the Imager, it is essential that the Imager be properly configured to harness its extensive capabilities and gain maximum efficiency.

There are several ways to configure the Imager. The best way is to set the parameters for each application allowing the required degrees of freedom. In some cases it is recommended to allow the user to select between the various operational modes or use cases, each with its own set of parameters.

Zebra mobile computers using the EMDK may utilize the SCAN and/or RSM APIs to configure the operation of the Imager. Zebra terminals that cannot use the EMDK, may configure some operations of the Imager by scanning special configuration bar codes (see [Miscellaneous Imager Options on page 66](#)) as done with many of Zebra bar code scanners.

A selection of most configured Imager parameters can be set with the Remote Scanner Management Sample (RSMSample) application installed on all Zebra mobile computers supporting the Imager. Some of the Imager parameters can also be set by the Control Panel application.

Once connected to a mobile computer, the application running on the mobile computer overrides the Imager parameters previously set.

Control Panel Application

The Control Panel (CTLpanel) application can be used for configuring the Imager by changing its values. The Control Panel application also enables one to retrieve and display the current setting of each value.

The Control Panel application together with the RSMsample application enable the user to configure the RS507. Users with Mobile computer that do not have the Control Panel application installed can download the application (CtlPanelWM.exe) and related documentation from the Support Central site at: <http://www.zebra.com/support>.

The following example describes how to read and configure new values of the Imager attributes.

To set new attribute values:

1. When using the WT4XXX, from the App Launcher screen, open the Utilities folder and start the Control Panel application. When using a mobile computer with Windows Mobile, open the Application folder and start the CtlPanelWM application.

Figure 35 Starting the Control Panel Application

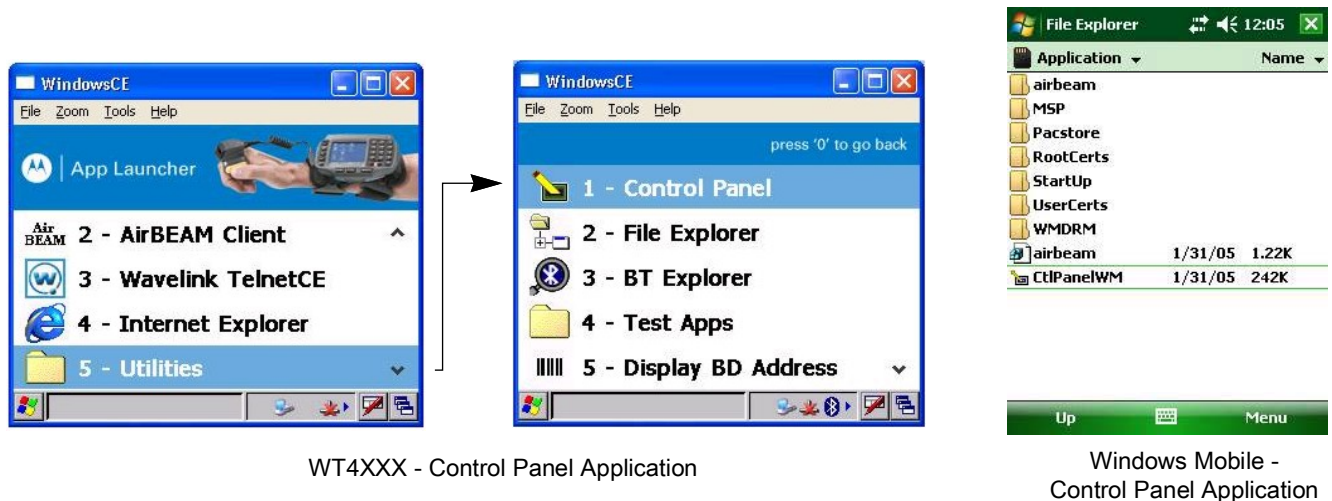

WT4XXX - Control Panel Application

Windows Mobile - Control Panel Application

2. Select Scanner Settings

Figure 36 Scanner Settings



- Use the > < keys to select scanner. Select SCN1 for corded Imager or SCN2 for cordless Imager (Bluetooth).

✓ **NOTE:** Before you select *SCN2* make sure to pair and connect the Imager to the mobile computer.

- Select Reader Params...

Figure 37 Reader Params

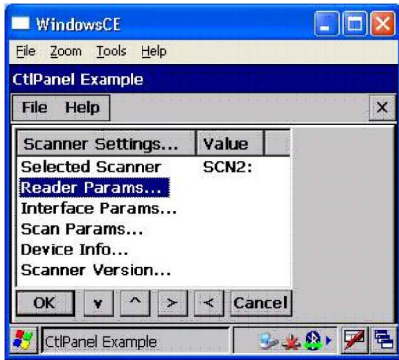

- Use the > < keys to change the Picklist Mode to Enable and press the OK button.

Figure 38 Picklist Mode

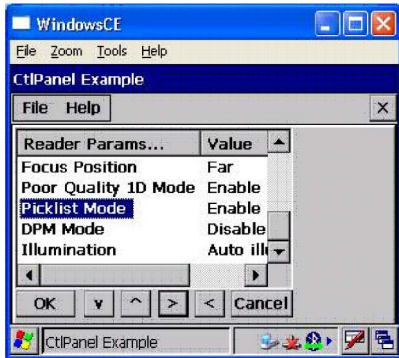

This setting is retained until cold boot is performed to the mobile computer or new setting is entered through the Control Panel application.

- Re-start your scan application and verify that Picklist Mode is enabled.

RSMSample Application

The Remote Scanner Management Sample (RSMSample) application is used for configuring the Imager by changing its attribute values. The RSMSample application also enables one to retrieve and display the current setting of each attribute. Users with mobile computer that do not have the RSMSample application installed can download the application and related documentation from the Support Central site at: www.zebra.com/support.

✓ **NOTE:** When the Imager is connected to a mobile computer, configuration by scanning bar codes is disabled. In such case, the Imager configuration is performed by the application (e.g RSMSamplen) running on the mobile computer. The new configuration overrides the previous configuration. The new configuration is saved in the Imager memory after disconnecting the Imager from the mobile computer or terminating the application.

The following example describes how to read and configure new values of the Imager attributes.

To set new attribute values:

1. From the mobile computer Application folder, run the RSMSample application.

Figure 39 Mobile Computer Application Folder - RSMSample Application Icon

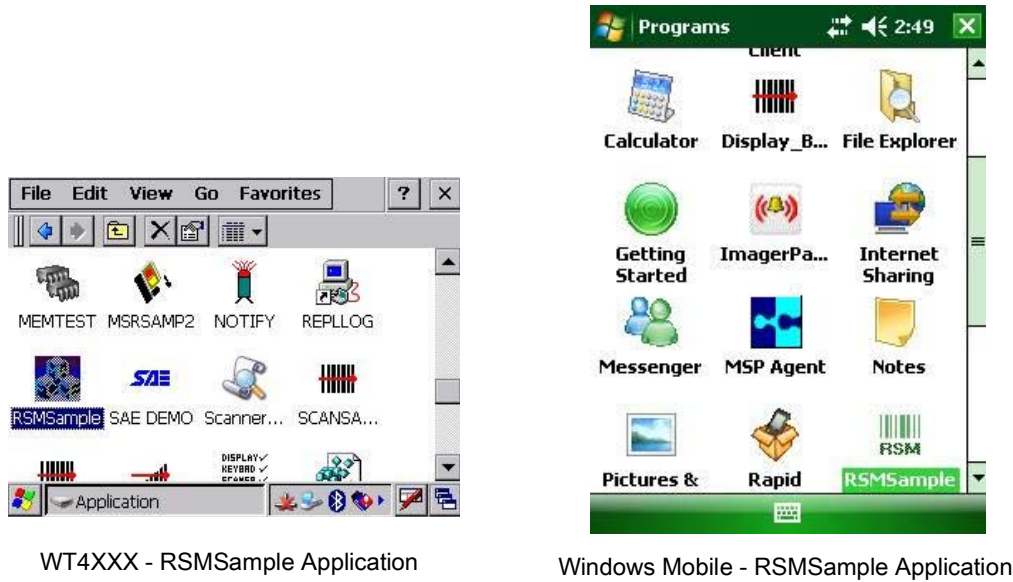

2. From the Dialog window, select Bluetooth SSI Scanner Driver.

Figure 40 Dialog Window - Bluetooth SSI Scanner Driver



3. Press the **Get All Supported Attributes** button to display all supported attributes.

Figure 41 RSMSample Application - Get All Supported Attributes Button

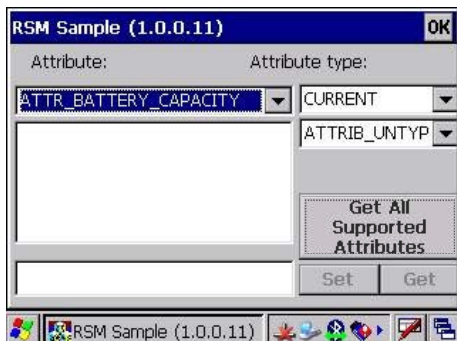

- The Attribute scroll window displays all supported attributes (see [Table on page 53](#)) and an operation success indication.

Figure 42 RSM Sample Application - Attribute Scroll Window

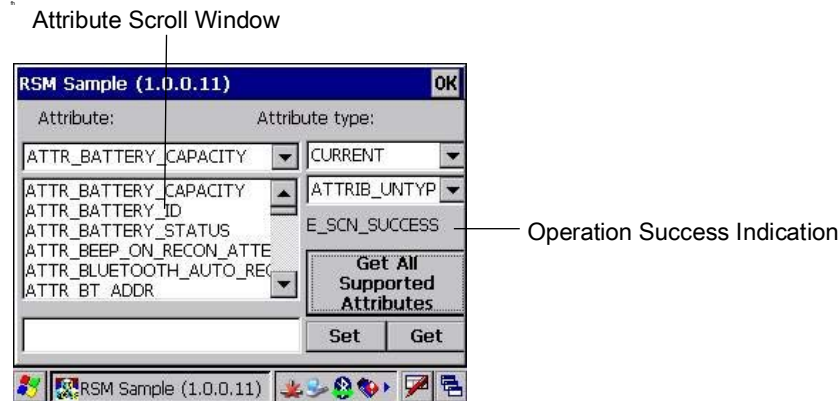

- Select the attribute you wish to change and press the **Get** button to display the current value of the attribute.

Figure 43 RSM Sample Application - Get Button

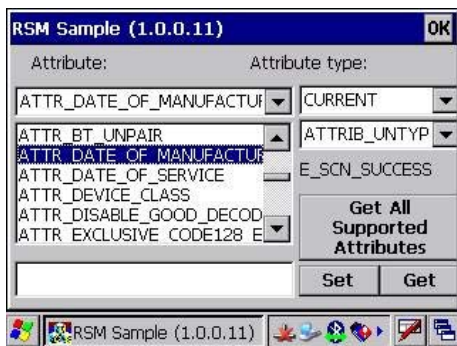

- The application returns the current value settings of the attribute.

Figure 44 RSM Sample Application - Current Value Settings of Attribute

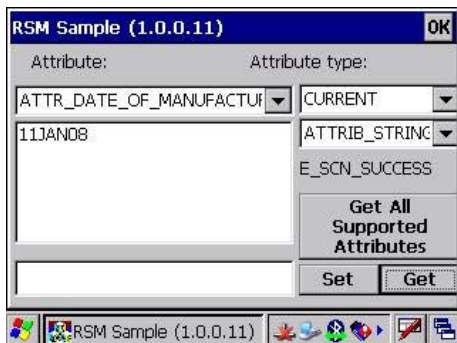

- Press again the **Get All Supported Attributes** button to show all supported attributes (see [Figure 45](#)).
- Select an attribute (see [Table](#)), enter the new value and press the **Set** button.

Figure 45 RSMSample Application - Setting an Attribute

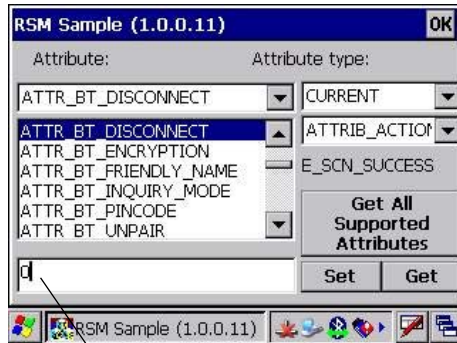

Value Line

In the following example, after setting the ATTR_BT_DISCONNECT attribute to 0 (disconnect), the Bluetooth radio of the Imager is turned off successfully as indicated by the change of the Bluetooth icon from Bluetooth Connection icon to Bluetooth Disabled icon.

Figure 46 RSMSample Application - Bluetooth Radio Turned Off Successfully Indication

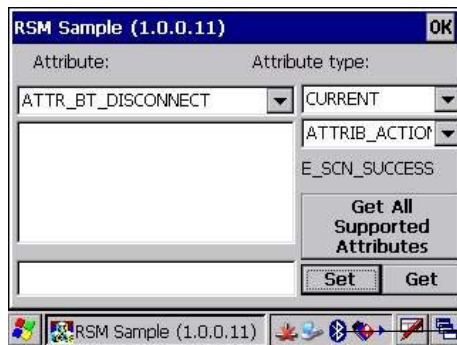

Bluetooth Disabled icon

Imager Attributes

Table lists the Imager attributes that can be changed using the RSMSample application.

Table 7 Imager Attributes

Attribute	Access	Values	Factory Default	Description
ATTR_SCANLINE_WIDTH	R/W	0 – (Pick list disabled) 2 – Narrow (Pick list enabled)	0	Width of laser scan line or size of Imager's effective Field of View (Pick list)
ATTR_DISABLE_GOOD_DECODE E_LED_BEEP	R/W	0- Enabled automatically green LED and beep on good decode. 1- Disabled		Good decode feedback on Imager
ATTR_MODEL_NUMBER	R	N/A	N/A	Model number

Table 7 Imager Attributes

Attribute	Access	Values	Factory Default	Description
ATTR_SERIAL_NUMBER	R	N/A	N/A	Serial number
ATTR_DATE_OF_MANUFACTURE	R	N/A	N/A	Date of manufacture
ATTR_DATE_OF_SERVICE	R	N/A	N/A	Last date of repair by Zebra
ATTR_BT_ADDR	R	N/A	N/A	Imager Bluetooth address
ATTR_BT_AUTHENTICATION	R/W	1 - Enabled 0 - Disabled	1	Enable Bluetooth authentication (Permanently saved)
ATTR_BT_ENCRYPTION	R/W	1 - Enabled 0 - Disabled	1	Enable encryption over Bluetooth (Permanently saved)
ATTR_BT_PINCODE	R/W	Up to six characters	"12345"	Pin code when Bluetooth Authentication is enabled (Permanently saved)
ATTR_RECONNECT_ATTEMPTS	R/W	6 = 30 sec, 7 = 35 sec, 8 = 40 sec, 9 = 45 sec, 10 = 50 sec, 11 = 55 sec, 12 = 60 sec	6	Reconnect attempt duration when the Imager is out of range
ATTR_BEEP_ON_RECON_ATTEMPT	R/W	1 - Enabled 0 - Disabled	0	When enabled, the Imager emits 5 short high beeps every 5 seconds while the reconnection attempt is in progress
ATTR_HID_AUTO_RECON	R/W	0 - Never Reconnect 1 - Reconnect on Data 2 - Reconnect immediately	0	Auto-reconnect behavior when connection is lost.
ATTR_BT_FRIENDLY_NAME	R/W	Up to 23 characters	"RS507"	Friendly name displayed by Bluetooth remote devices (Permanently saved).
ATTR_PIN_CODE_TYPE	R/W	1 - User prompt 0 - Automatically use stored PIN code	0	Prompt the user for PIN code or use PIN code stored in memory.

Table 7 Imager Attributes

Attribute	Access	Values	Factory Default	Description
ATTR_BT_INQUIRY_MODE	R/W	1 - Limited 0 - General	0	The used inquiry mode: Limited: The Imager finds only an associated device. General: The Imager finds all the visible devices.
ATTR_EXCLUSIVE_CODE128_EN	R/W	1 - Enabled 0 - Disabled	0	Ignore Code 128 beginning with 420 and 421
ATTR_MEMS_ENABLE	R/W	1 - Enabled 0 - Disabled	Trigger Model -0 Triggerless Model -1	Motion trigger feature
ATTR_PROXIMITY_ENABLE	R/W	1 - Enabled 0 - Disabled	Trigger Model -0 Triggerless Model -1	Proximity feature
ATTR_PROXIMITY_DISTANCE	R/W	0 – Short 1 – Mid 2 – Long	2	Proximity distance
ATTR_PAGING_ENABLE	R/W	1 - Enabled 0 - Disabled	0	Paging device enable / disable
ATTR_PAGING_BEEP_SEQ	R/W	0-26	15	Paging beep sequence Beep pattern values.
ATTR_LOW_BATTERY_IND_EN	R/W	1 - Enabled 0 - Disabled	0	Low battery indication.
ATTR_SCAN_TRIG_WAKEUP_EN	R/W	1 - Enabled 0 - Disabled	1	Scan trigger serves as an Imager wake-up source from low power.

Table 7 Imager Attributes

Attribute	Access	Values	Factory Default	Description
ATTR_BLUETOOTH_AUTO_RECON	R/W	0 –None 1 - Power on 2 - On when back in range 3 - On when power is on and back within range	2	Defines Bluetooth reconnection scheme (Permanently saved) Important: If option 1 (On Power) or 3 (On when power is on and back within range) is set, the pair should be properly marked and kept visible on the Imager and mobile computer to avoid user selecting of an unpaired set.
ATTR_PROXIMITY_CONTINUOUS_EN	R/W	1 - Enabled 0 - Disabled	0	Proximity continuous mode (for scanning packages off conveyer belt).
ATTR_GOOD_SCANS_DELAY	R/W	Values 0 -150 (in 100 msec intervals) 0 – No delay 1 – 150 (100 – 15000 msec)	0	Delay between good scans in proximity continuous mode (msec).
ATTR_FORCE_PAIRING_SAVE	R/W	0 – Disabled 1 – Enabled	1	Force BD_Address saving when pairing fails (Permanently saved).
ATTR_PAGING_ACTIVATE	W	0 – Stop 1 – Start		Start / stop Imager paging
ATTR_BT_DISCONNECT	W	0 - Disconnected		Bluetooth disconnect command from terminal to Imager
ATTR_BT_UNPAIR	W	0 - Unpaired		Bluetooth un-pair command from terminal to Imager.
ATTR_FIRM_VERSION	R	N/A		Imager Firmware version.
ATTR_DEVICE_CLASS	R	N/A		Imager system class

Table 7 Imager Attributes

Attribute	Access	Values	Factory Default	Description
ATTR_BATTERY_STATUS	R	0- Unknown 1- Full 2- Medium 3- Empty 4- Charging – full rate 5- Charging – half rate 6- Charging – Trickle 7- Discharging – Battery Cycle in progress		Battery Status
ATTR_BATTERY_CAPACITY	R	0-100 (battery percent) 9999 if error (no battery)		Battery capacity
ATTR_BATTERY_ID	R	0 – Simple 1 – Double 2 – Cabled 9999 – Error		Battery ID
ATTR_TRIGGERLESS_MODE	R/W	0 - Disable 1 - Enable	0	Triggerless mode

Imager Motion and Proximity Configuration

The Imager proximity and motion feature enables auto-triggering of the Imager upon motion and/or proximity to an object.

Motion and proximity detection can be enabled or disabled by the mobile computer application such as the Remote Scanner Management (RSMSample) application of the mobile computer (see [“RSMSample Application” on page 8-50](#)) or by scanning configuration bar codes (see [Miscellaneous Imager Options on page 66](#)).

✓ **NOTE:** Once configured, the motion and/or proximity attributes are retained in the Imager memory following warm or cold boot.

Operation Modes

The Imager can be configured to a single or continuous scan operation. In most use cases, a single scan mode is the preferred operation. However, when scanning packages off a moving conveyer belt, it is sometimes recommended to use the continuous scan mode (also referred to as 'Proximity Continuous' mode). Continuous operation automatically results from the combined settings of motion and proximity (enabling or disabling motion and/or proximity. See [Table](#)). The Imager is provided with motion and proximity enabled by default.

To set new values to the motion and/or proximity attributes, refer to [Imager Attributes on page 53](#).

Table 8 Imager Operation Modes

Mode Number	Parameter States (Motion / Proximity / Continuous Scan)	Description
1	Motion: enabled Proximity: enabled Continuous scan: disabled	The Imager performs a single scan when moved and positioned in proximity to an object. Scanning resumes when the Imager is moved and re-positioned in proximity to an object. This mode is a default mode.
2	Motion: disabled Proximity: enabled Continuous scan: disabled	The Imager starts to continuously scan when positioned in proximity to an object. The Imager stops scanning when the object is out of proximity range.
3	Motion: enabled Proximity: disabled Continuous scan: disabled	Upon movement, the Imager performs a single scan and stops.
4	Motion: enabled Proximity: enabled Continuous scan: enabled	The Imager performs a continuous scan when moved and positioned in proximity to an object. The Imager continues to scan as long as it detects an object within its range and bar codes are scanned successfully. The Imager stops scanning if proximity to an object is not detected, or if the Imager fails to scan three consecutive times.
5	Motion: disabled Proximity: enabled Continuous scan: enabled	The description of this operation mode is identical to the description of mode number 2 in this table.

Configuring Motion and Proximity by Scanning Bar Codes

✓ **NOTE:** Scanning bar codes for configuring motion and/or proximity is enabled only when the Imager is in cordless (Bluetooth) configuration.

To enable or disable motion or proximity, perform cold boot by removing and re-installing the battery (see [Remove the Battery on page 20](#)).

✓ **NOTE:** Throughout this section, configuration bar codes shown with asterisks (*) indicate default values.

Motion Sensing Control

Disable Motion Trigger



*Enable Motion Trigger



Proximity Sensing Control

Disable Proximity



*Enable Proximity



Proximity Continuous Enable

The Proximity Continuous Enable parameter enables/disables the proximity continuous feature.

*Disable Proximity Continues



Enable Proximity Continues



The Proximity Distance parameter sets the proximity sensitivity range.

Short Range



Mid Range



*Long Range



Good Scan indication delay Control

The Good Scan Delay parameter sets a delay between good scans when scanning is in continuous mode.

This delay is effective when:

- Motion detection - Enabled
- Proximity - Enabled
- Proximity continues - Enabled

Or

- Motion detection - Disabled
- Proximity - Enabled

0 msec



200 msec



400 msec



*600 msec



800 msec



1000 msec



1200 msec



1400 msec



1600 msec



1800 msec



2000 msec



Real Time Logger

The Imager includes a Real Time Logger application that logs events, errors, exceptions and software diagnostics of the Imager during its operation. Each log record has a time stamp with a 1ms resolution. The logger time is synchronized with the host computer's time. The log is retained only after warm boot. The log memory size is 4 MB and operates in a cyclic way.

Figure 47 shows the Real Time Logger file content as shown on a host computer screen.

Figure 47 Real Time Logger Content Screen

```

log1.txt - Notepad
File Edit Format View Help
JAN 01 08 00:00:00:100 01      Logger Task 0 Cold Boot logger module
JAN 01 08 00:00:00:100 01      Logger Task 0 logger module initialized successfully
JAN 01 08 00:00:00:100 02      System Exec Task 2 RS507 PRODUCT HARDWARE VERSION P2
JAN 01 08 00:00:00:100 02      System Exec Task 2 RS507 PRODUCT RELEASE VERSION PAAAC
-S00-AAA-N51
JAN 01 08 00:00:00:100 02      System Exec Task 2 RS507 PRODUCT RELEASE DATE 12-
Nov-2008
JAN 01 08 00:00:00:100 05      System Exec Task 0 sw_diags_init: SW diags parameters
cleared
JAN 01 08 00:00:00:200 05      System Exec Task 0 sw_diags_init: Successfully
initialized
JAN 01 08 00:00:00:200 07      PMF Task 0 PMF: init passed successfully.
JAN 01 08 00:00:00:200 02      System Exec Task 2 SysConfig 1
JAN 01 08 00:00:00:200 02      System Exec Task 2 NVP:op=1
JAN 01 08 00:00:00:200 02      System Exec Task 2 Size of PARAMBUF_T (696)
JAN 01 08 00:00:00:200 02      System Exec Task 2 NVP:init case:
JAN 01 08 00:00:00:300 02      System Exec Task 2 D
JAN 01 08 00:00:00:300 02      System Exec Task 2
JAN 01 08 00:00:00:300 02      System Exec Task 2 NVP:op=3
JAN 01 08 00:00:00:300 06      System Exec Task 0 Battery id = 1 (double)
JAN 01 08 00:00:00:300 06      System Exec Task 0 Battery successfully initiated

```

✓ **NOTE:** To retrieve logs, use the PC Tool application.

Imager Firmware Update

Required Equipment

The following hardware is required for updating the firmware of the Imager:

- Host computer
- Mobile computer
- USB / RS232 interface cable or any cradle set-up used for establishing an ActiveSync connection between the host computer and mobile computer.

The following software is required for updating the firmware of the Imager:

- New Imager firmware file (*.DAT file format)
- CAB file to install in the mobile computer.
- ActiveSync application installed on the host computer and the mobile computer (for copying the new Imager firmware and RS507 CAB files from the host computer to the mobile computer).
- FirmwareUpdate application installed in the mobile computer (part of the CAB file installation). This application is used for downloading the firmware file from the mobile computer to the Imager.

Updating the RS507 Firmware

Before using the FirmwareUpdate application:

1. Exit all scanning applications running on the mobile computer.
2. Verify that the mobile computer battery is fully charged or that the mobile computer is connected to an external power source.
3. When using a corded Imager, verify that the Imager is properly connected to the mobile computer. When using a cordless Imager verify that the Imager battery is fully charged.

To upgrade the Imager firmware:

1. Connect the Imager to the mobile computer that supports the RS507.
2. Start the FirmwareUpdate application located in the Application folder for WinCE devices or under Start / Programs for Windows Mobile devices (the FirmwareUpdate application and related documentation can be downloaded from the Support Central site at: <http://www.zebra.com/support>).

Figure 48 FirmwareUpdate Application Icon

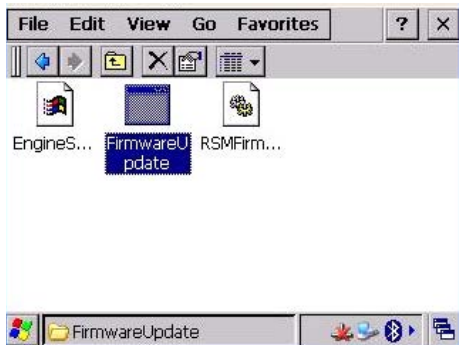

3. Select the interface method (Bluetooth in the following example).



NOTE: The following screen is displayed only when using the WT4XXX. In other mobile computers, Bluetooth mode is selected by default. Press **Yes** (Bluetooth mode) to pair the Imager with the mobile computer (see [Restore Lost Bluetooth Connection on page 27](#)).

Figure 49 Selection of the Bluetooth Interface Mode

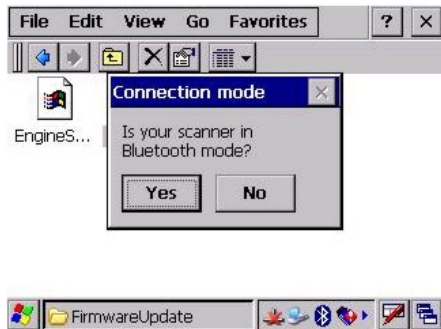

4. Press the **Firmware** button and verify that the application shows the version number of the current firmware of the Imager.

Figure 50 Firmware Update Screen

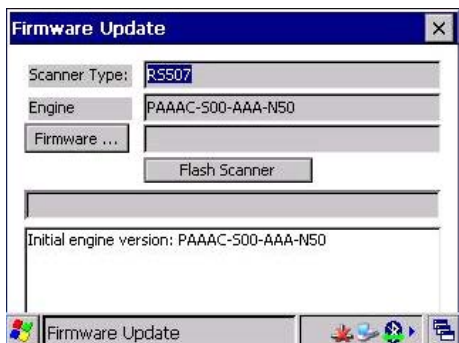

5. Copy the *.DAT file to the mobile computer using ActiveSync connection.

6. Press the **Firmware...** button to select the new firmware *.DAT file and the **OK** button.

Figure 51 Firmware Update Screen - Selection of *.DAT File



7. Press the **Flash Scanner** button to start updating the firmware.

Figure 52 Firmware Update Screen - Flash Scanner Button

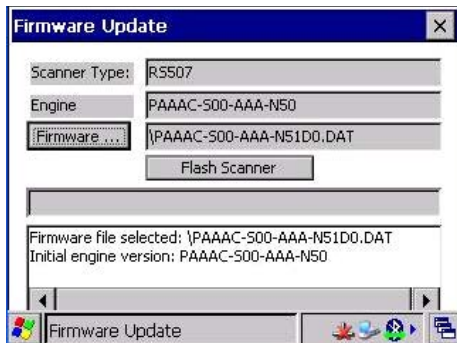

8. Verify that the firmware download starts. When the download starts, the **### Starting Firmware Download!** message displays. Firmware download is completed when the Update engine version... message is displayed.

Figure 53 Firmware Update Screen - "Starting Firmware Download!" Message

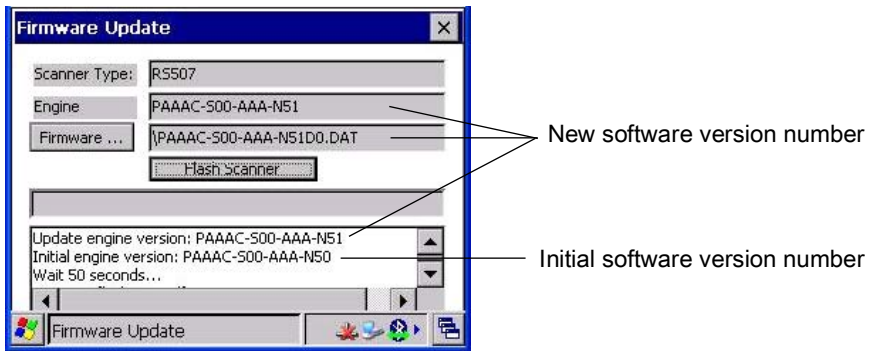

9. Pair the Imager with the mobile computer (see [Restore Lost Bluetooth Connection on page 27](#)).
10. Verify that the firmware download is completed by looking at the Initial software version number and the new software version number.

Figure 54 Firmware Update Screen

11. Press the **Esc** key on the mobile computer or the X in the top right corner of the application window to exit the FirmwareUpdate application.

Miscellaneous Imager Options

Introduction

The Imager is intended to operate hand in hand with the mobile computer to which it is connected.

The mobile computer automatically loads configuration data whenever connected to an Imager (corded or cordless). This operation does not require scanning configuration bar codes. Using configuration bar codes is only available for a cordless Imager when decontrolled from the mobile computer.

It is recommended to use configuration bar codes only for setting parameters that cannot be configured by the other mobile computer application.

✓ **NOTE:** Imager parameters set by scanning configuration bar codes, persist in the Imagers memory.

The Imager ships with the settings shown in [Table 9 on page 67](#) (also see [Standard Default Parameters on page 226](#) for host device and miscellaneous defaults). If the default values suit the requirements, programming is not necessary.

✓ **NOTE:** Most computer monitors allow scanning the bar codes directly on the screen (when using the imaging engine). When scanning from the screen, be sure to set the document magnification to a level where you can see the bar code clearly, and bars and/or spaces are not merging.

To return all features to default values, scan the [Set Default Parameter on page 68](#). Throughout the programming bar code menus, asterisks indicate (*) default values.



* Indicates Default — ***High Volume** — Feature/Option
(00h) — Option Hex Value for programming via SSI command

Scanning Sequence Examples

In most cases, scanning one bar code sets the parameter value. For example, to set the beeper tone to high, scan the **High Frequency** (beeper tone) bar code listed under [Beeper Tone on page 70](#). The Imager issues a fast warble beep and the LED turns green, signifying a successful parameter entry.

Other parameters, such as **Serial Response Time-Out** or **Data Transmission Formats**, require scanning several bar codes. See these parameter descriptions for this procedure.

Errors While Scanning

Unless otherwise specified, to correct an error during a scanning sequence, just re-scan the correct parameter.

User Preferences/Miscellaneous Options Parameter Defaults

Table 9 lists defaults for user preferences parameters.

Scan the appropriate bar codes in this guide. These new values replace the standard default values in memory. To recall the default parameter values, scan the [Set Default Parameter on page 68](#).

✓ **NOTE:** See [Standard Default Parameters on page 226](#) for all user preferences, hosts, symbologies, and miscellaneous default parameters.

Table 9 User Preferences Parameter Defaults

Parameter	Parameter Number	Default	Page Number
User Preferences			
Motion Sensing Control		Enabled	58
Proximity Sensing Control		Enabled	59
Proximity Continuous		Enabled	59
Proximity Continuous Enable		Disabled	59
Good Scan indication delay Control		600 ms	60
Set Default Parameter		Set Defaults	68
Parameter Bar Code Scanning	ECh	Enabled	69
Beep After Good Decode	38h	Enabled	69
Beeper Tone	91h	Medium	70
Beeper Volume	8Ch	High	71
Picklist Mode	F0h 92h	Disabled Always	73
Fuzzy 1D Processing	F1h 02h	Enabled	74
Decoding Illumination	F0h, 2Ah	Enabled	75
Miscellaneous Options			
Transmit Code ID Character	2Dh	None	78
Prefix Value	63h, 69h	7013 <CR><LF>	79

Table 9 User Preferences Parameter Defaults (Continued)

Parameter	Parameter Number	Default	Page Number
Suffix 1 Value Suffix 2 Value	62h 68h 64h 6Ah	7013 <CR><LF>	79
Scan Data Transmission Format	EBh	Data as is	80
FN1 Substitution Values	67h 6Dh	Set	82
Transmit "No Read" Message	5Eh	Disabled	83
Bluetooth Pairing Bar Code		None	26
Bluetooth Un-pairing Bar Code		None	27

User Preferences

Set Default Parameter

You can reset the Imager to two types of defaults: factory defaults or custom defaults. Scan the appropriate bar code below to reset the decoder to its default settings and/or set its current settings as custom defaults.

- **Set Defaults** - Scan this bar code to reset all parameters to custom default settings.
- **Set Factory Defaults** - Scan this bar code to restore the factory default values listed in [Table 18](#). This deletes any custom defaults set.



***Set Defaults**



Set Factory Defaults

Parameter Bar Code Scanning

Parameter # ECh

To disable the decoding of parameter bar codes, including the **Set Defaults** parameter bar codes, scan the **Disable Parameter Scanning** bar code below. To enable decoding of parameter bar codes, scan **Enable Parameter Scanning**.



***Enable Parameter Bar Code Scanning
(01h)**



**Disable Parameter Bar Code Scanning
(00h)**

Beep After Good Decode

Parameter # 38h

Scan a bar code below to select whether or not the Imager beeps after a good decode. If selecting **Do Not Beep After Good Decode**, the beeper still operates during parameter menu scanning and to indicate error conditions.



***Beep After Good Decode
(Enable)
(01h)**

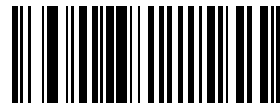

**Do Not Beep After Good Decode
(Disable)
(00h)**

Beeper Tone

Parameter # 91h

To select a decode beep frequency (tone), scan one of the following bar codes.



Low Tone
(02h)



***Medium Tone**
(01h)

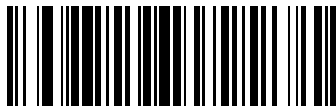

High Tone
(00h)

Beeper Volume

Parameter # 8Ch

To select a beeper volume, scan the **Low Volume**, **Medium Volume**, or **High Volume** bar code.



Low Volume
(02h)



Medium Volume
(01h)



***High Volume**
(00h)

Imager Activity Modes

The Imager is capable of four modes of activity:

- **Busy (Run) Mode** – The Imager is scanning or transferring data using Bluetooth.
- **Standby Mode** – The Imager enters Standby mode (Low Power Mode) when it is idle for more than one second. The Imager wakes-up and returns to busy (run) mode upon at least one of the following events:
 - Scan trigger
 - Motion activity
 - Bluetooth activity
 - Press of the Restore key
 - Real time clock (a system inside the Imager)
- **Deep Sleep (Critical Off) Mode** – The deep sleep mode is only applicable when the Imager is connected to a mobile computer in cordless mode. When the battery voltage of the Imager is below 3V, the Imager turns off and enters Standby mode. To recover from Deep Sleep mode, replace the battery with a charged battery ([Remove the Battery on page 20](#))
- **OFF Mode** – The Imager is not connected to power source.

Picklist Mode

Parameter # F0h 92h

Picklist mode enables the Imager to decode only bar codes that are aligned under the laser crosshair. Select one of the following picklist modes for the Imager:

- **Disabled Always** - Picklist mode is always disabled.
- **Enabled Always** - Picklist mode is always enabled.

✓ **NOTE:** For the DS9808-LR, if you configure Trigger B for Imager Decoding and enable Picklist Mode, activating Trigger B turns on the imager aiming pattern, and releasing the trigger activates decoding.



***Disabled Always
(00h)**



**Enabled Always
(02h)**

Fuzzy 1D Processing

Parameter # F1h 02h

This option is enabled by default to optimize decode performance on 1D bar codes, including damaged and poor quality symbols. Disable this only if you experience time delays when decoding 2D bar codes, or in detecting a no decode.



***Enable Fuzzy 1D Processing
(01h)**



**Disable Fuzzy 1D Processing
(00h)**

Decoding Illumination

Parameter # F0h, 2Ah

Selecting **Enable Decoding Illumination** causes the Imager to flash illumination to aid decoding. Select **Disable Decoding Illumination** to prevent the Imager from using decoding illumination.

Enabling illumination usually results in superior images. The effectiveness of the illumination decreases as the distance to the target increases.



***Enable Decoding Illumination
(01h)**



**Disable Decoding Illumination
(00h)**

Low Battery Indication Cycle

The Low Battery Indication Cycle parameter sets low battery indication recurrence.

*Every 10 seconds



Every 20 seconds



Every 30 seconds



Every 40 seconds



Every 50 seconds



Bluetooth Disconnection Alert Control

Bluetooth Disconnect Indication

When this parameter is enabled, the RS507 plays a beep every 10 sec when the RS507 Bluetooth is disconnected.

*Disable



Bluetooth Disconnect Indication After Battery Insert

Time delay for Bluetooth disconnect indication after battery installed.

60 Seconds



180 seconds



240 Seconds



300 Seconds



Bluetooth Disconnect Indication After Bluetooth Disconnection

Time delay for Bluetooth disconnect indication after Bluetooth disconnection.

*30 Seconds



60 Seconds



90 Seconds



120 Seconds



Bluetooth Disconnect Indication - Beep Duration

* 3 High/Short Beeps



3 Low/Short Beeps



3 High/Long beep.



High/Low/High Beep



Bluetooth Disconnect Indication - LED Indication

Green LED turns on for 600ms



Green LED turns on for 1000ms



Red LED turns on for 600ms



*Red LED turns on for 600ms



Miscellaneous Scanner Parameters

Transmit Code ID Character

Parameter # 2Dh

A Code ID character identifies the code type of a scanned bar code. This is useful when decoding more than one code type. In addition to any single character prefix already selected, the Code ID character is inserted between the prefix and the decoded symbol.

Select no Code ID character, a Symbol Code ID character, or an AIM Code ID character. For Code ID Characters, see [Symbol Code Identifiers on page 231](#) and [AIM Code Identifiers on page 232](#).

- ✓ **NOTE:** If you enable Symbol Code ID Character or AIM Code ID Character, and enable [Transmit "No Read" Message on page 83](#), the Imager appends the code ID for Code 39 to the NR message.



Symbol Code ID Character
(02h)

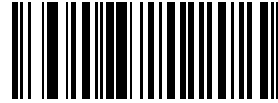

AIM Code ID Character
(01h)

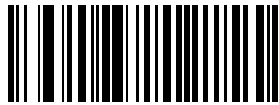

***None**
(00h)

Prefix/Suffix Values

Key Category Parameter # P = 63h, S1 = 62h, S2 = 64h

Decimal Value Parameter # P = 69h, S1 = 68h, S2 = 6Ah

You can append a prefix and/or one or two suffixes to scan data for use in data editing. To set a value for a prefix or suffix, scan a four-digit number (i.e., four bar codes from [Numeric Bar Codes on page 241](#)) that corresponds to that value.

When using host commands to set the prefix or suffix, set the key category parameter to 1, then set the 3-digit decimal value.

To correct an error or change a selection, scan [Cancel on page 242](#).



NOTE: To use Prefix/Suffix values, first set the [Scan Data Transmission Format on page 80](#).

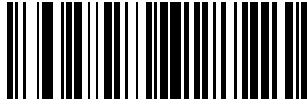

**Scan Prefix
(07h)**



**Scan Suffix 1
(06h)**



**Scan Suffix 2
(08h)**

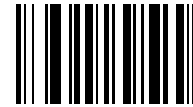

Data Format Cancel

Scan Data Transmission Format

Parameter # EBh

To change the scan data format, scan one of the following eight bar codes corresponding to the desired format.

✓ **NOTE:** If using this parameter do not use ADF rules to set the prefix/suffix.

To set values for the prefix and/or suffix, see [Prefix/Suffix Values on page 79](#).



***Data As Is
(00h)**



**<DATA> <SUFFIX 1>
(01h)**



**<DATA> <SUFFIX 2>
(02h)**



**<DATA> <SUFFIX 1> <SUFFIX 2>
(03h)**



**<PREFIX> <DATA >
(04h)**

Scan Data Transmission Format (continued)



<PREFIX> <DATA> <SUFFIX 1>
(05h)



<PREFIX> <DATA> <SUFFIX 2>
(06h)



<PREFIX> <DATA> <SUFFIX 1> <SUFFIX 2>
(07h)

FN1 Substitution Values

Key Category Parameter # 67h

Decimal Value Parameter # 6Dh

The Wedge and USB HID Keyboard hosts support a FN1 Substitution feature. Enabling this substitutes any FN1 character (0x1b) in an EAN128 bar code with a value. This value defaults to 7013 (Enter Key).

When using host commands to set the FN1 substitution value, set the key category parameter to 1, then set the 3-digit keystroke value. See the ASCII Character Set table for the current host interface for the desired value.

To select a FN1 substitution value via bar code menus:

1. Scan the bar code below.

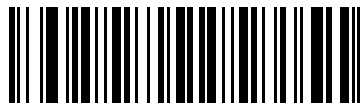

Set FN1 Substitution Value

2. Locate the keystroke desired for FN1 Substitution in the ASCII Character Set table for the current host interface. Enter the 4-digit ASCII Value by scanning each digit in [Numeric Bar Codes on page 241](#).

To correct an error or change the selection, scan **Cancel**.

To enable FN1 substitution for USB HID keyboard, scan the **Enable FN1 Substitution** bar code on page [82](#).

Transmit “No Read” Message

Parameter # 5Eh

Scan a bar code below to select whether or not to transmit a No Read message. Enable this to transmit the characters NR when a bar code does not decoded. Disable this to send nothing to the host if a symbol does not decode.



NOTE: If you enable **Transmit No Read**, and also enable Symbol Code ID Character or AIM Code ID Character for [Transmit Code ID Character on page 78](#), the Imager appends the code ID for Code 39 to the NR message.



**Enable No Read
(01h)**



***Disable No Read
(00h)**

Symbologies

Introduction

This chapter describes symbology features and provides programming bar codes for selecting these features. Before programming, follow the instructions in [Getting Started](#).

- ✓ **NOTE:** When the Imager is connected to a mobile computer, configuration by scanning bar codes is disabled. In such case, programming the Imager is performed by an application running on the mobile computer.

When the Imager is connected to a mobile computer, the configuration application running on the mobile computer may override the parameters previously entered by scanning. Once configured, the new parameters are saved in the Imager memory after disconnecting the Imager or terminating the application.

To set feature values, scan a single bar code or a short bar code sequence. The settings are stored in non-volatile memory and are preserved even when the Imager powers down.

Select a host type after the power-up beeps sound. This is only necessary upon the first power-up when connected to a new host.

To return all features to default values, scan the default bar code (see [Set Default Parameter on page 68](#)). Throughout the programming bar code menus, asterisks (*) indicate default values.

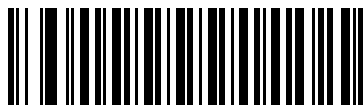

* Indicates Default — *Enable UPC-A — Feature/Option
(01h) — Option Hex Value for programming via SSI command

Scanning Sequence Examples

In most cases, scanning one bar code sets the parameter value. For example, to transmit bar code data without the UPC-A check digit, simply scan the **Do Not Transmit UPC-A Check Digit** bar code under [Transmit UPC-A Check Digit on page 97](#). The Imager issues a fast warble beep and the LEDs turn green, signifying a successful parameter entry.

Other parameters, such as **Set Length(s) for D 2 of 5** require scanning several bar codes. See the individual parameter, such as **Set Length(s) for D 2 of 5**, for this procedure.

Errors While Scanning

Unless otherwise specified, to correct an error during a scanning sequence, just re-scan the correct parameter.

Symbology Parameter Defaults

Table 10 lists the defaults for all symbology parameters. There are two ways to change the default values:

- Scan the appropriate bar codes in this guide. These new values replace the standard default values in memory. To recall the default parameter values, scan the [Set Default Parameter on page 68](#).
- Download data through the device's serial port using SSI. Hexadecimal parameter numbers appear in this chapter below the parameter title, and options appear in parenthesis beneath the accompanying bar codes. Refer to the Simple Serial Interface (SSI) Programmer's Guide for detailed instructions for changing parameters using this method.

✓ **NOTE:** See [Standard Default Parameters on page 226](#) for all user preferences, hosts, and miscellaneous default parameters.

Table 10 Parameter Defaults

Parameter	Parameter Number	Default	Page Number
UPC/EAN			
UPC-A	01h	Enabled	90
UPC-E	02h	Enabled	90
UPC-E1	0Ch	Disabled	91
EAN-8/JAN 8	04h	Enabled	91
EAN-13/JAN 13	03h	Enabled	92
Bookland EAN	53h	Disabled	92
Decode UPC/EAN/JAN Supplementals (2 and 5 digits)	10h	Ignore	94
User-Programmable Supplementals			96
Supplemental 1:	F1h 43h		
Supplemental 2:	F1h 44h		
UPC/EAN/JAN Supplemental Redundancy	50h	10	96
Decode UPC/EAN/JAN Supplemental AIM ID	F1h A0h	Combined	97
Transmit UPC-A Check Digit	28h	Enabled	97
Transmit UPC-E Check Digit	29h	Enabled	97
Transmit UPC-E1 Check Digit	2Ah	Enabled	98
UPC-A Preamble	22h	System Character	98
UPC-E Preamble	23h	System Character	98

Table 10 Parameter Defaults (Continued)

Parameter	Parameter Number	Default	Page Number
UPC-E1 Preamble	24h	System Character	100
Convert UPC-E to A	25h	Disabled	102
Convert UPC-E1 to A	26h	Disabled	102
EAN-8/JAN-8 Extend	27h	Disabled	103
Bookland ISBN Format	F1h 40h	ISBN-10	104
UCC Coupon Extended Code	55h	Disabled	105
ISSN EAN	F1h 69h	Disabled	105
Code 128			
Code 128	08h	Enabled	106
Set Length(s) for Code 128	D1h D2h	Any Length	106
GS1-128 (formerly UCC/EAN-128)	0Eh	Enabled	107
ISBT 128	54h	Enabled	108
ISBT Concatenation	F1h 41h	Disabled	109
Check ISBT Table	F1h 42h	Enabled	110
ISBT Concatenation Redundancy	DFh	10	110
Code 39			
Code 39	00h	Enabled	111
Trioptic Code 39	0Dh	Disabled	111
Convert Code 39 to Code 32 (Italian Pharmacy Code)	56h	Disabled	112
Code 32 Prefix	E7h	Disabled	112
Set Length(s) for Code 39	12h 13h	2 to 55	113
Code 39 Check Digit Verification	30h	Disabled	114
Transmit Code 39 Check Digit	2Bh	Disabled	114
Code 39 Full ASCII Conversion	11h	Disabled	115
Buffer Code 39	71h	Disabled	115
Code 93			
Code 93	09h	Disabled	118
Set Length(s) for Code 93	1Ah 1Bh	4 to 55	118
Code 11			
Code 11	0Ah	Disabled	120
Set Lengths for Code 11	1Ch 1Dh	4 to 55	120

Table 10 Parameter Defaults (Continued)

Parameter	Parameter Number	Default	Page Number
Code 11 Check Digit Verification	34h	Disabled	121
Transmit Code 11 Check Digit(s)	2Fh	Disabled	123
Interleaved 2 of 5 (ITF)			
Interleaved 2 of 5 (ITF)	06h	Enabled	123
Set Lengths for I 2 of 5	16h 17h	14	124
I 2 of 5 Check Digit Verification	31h	Disabled	126
Transmit I 2 of 5 Check Digit	2Ch	Disabled	126
Convert I 2 of 5 to EAN 13	52h	Disabled	127
Discrete 2 of 5 (DTF)			
Discrete 2 of 5	05h	Disabled	127
Set Length(s) for D 2 of 5	14h 15h	12	128
Codabar (NW - 7)			
Codabar	07h	Disabled	130
Set Lengths for Codabar	18h 19h	5 to 55	130
CLSI Editing	36h	Disabled	131
NOTIS Editing	37h	Disabled	132
MSI			
MSI	0Bh	Disabled	133
Set Length(s) for MSI	1Eh 1Fh	4 to 55	133
MSI Check Digits	32h	One	134
Transmit MSI Check Digit	2Eh	Disabled	135
MSI Check Digit Algorithm	33h	Mod 10/Mod 10	136
Chinese 2 of 5			
Chinese 2 of 5	F0h 98h	Disabled	136
Matrix 2 of 5			
Matrix 2 of 5	F1h 6Ah	Disabled	137
Matrix 2 of 5 Lengths	F1h 6Bh F1h 6Ch	1 Length - 14	138
Matrix 2 of 5 Redundancy	F1h 6Dh	Disabled	139
Matrix 2 of 5 Check Digit	F1h 6Eh	Disabled	139
Transmit Matrix 2 of 5 Check Digit	F1h 6Fh	Disabled	140

Table 10 Parameter Defaults (Continued)

Parameter	Parameter Number	Default	Page Number
Inverse 1D	F1h 4Ah	Regular	140
Postal Codes			
US Postnet	59h	Disabled	141
US Planet	5Ah	Disabled	141
Transmit US Postal Check Digit	5Fh	Enabled	142
UK Postal	5Bh	Disabled	142
Transmit UK Postal Check Digit	60h	Enabled	143
Japan Postal	F0h 22h	Disabled	143
Australian Postal	F0h 23h	Disabled	144
Netherlands KIX Code	F0h 46h	Disabled	144
USPS 4CB/One Code/Intelligent Mail	F1h 50h	Disabled	145
UPU FICS Postal	F1h 63h	Disabled	145
Mailmark		Enabled	145
GS1 DataBar			
GS1 DataBar-14	F0h 52h	Disabled	146
GS1 DataBar Limited	F0h 53h	Disabled	146
GS1 DataBar Expanded	F0h 54h	Disabled	147
Convert GS1 DataBar to UPC/EAN	F0h 8Dh	Disabled	147
Composite			
Composite CC-C	F0h 55h	Disabled	148
Composite CC-A/B	F0h 56h	Disabled	148
Composite TLC-39	F0h 73h	Disabled	149
UPC Composite Mode	F0h 58h	Never Linked	149
Composite Beep Mode	F0h 8Eh	Beep As Each Code Type is Decoded	150
GS1-128 Emulation Mode for UCC/EAN Composite Codes	F0h ABh	Disabled	150
2D Symbologies			
PDF417	0Fh	Enabled	151
MicroPDF417	E3h	Disabled	151
Code 128 Emulation	7Bh	Disabled	151

Table 10 Parameter Defaults (Continued)

Parameter	Parameter Number	Default	Page Number
Data Matrix	F0h 24h	Enabled	153
Data Matrix Inverse	F1h 4Ch	Regular	153
Maxicode	F0h 26h	Enabled	154
QR Code	F0h 25h	Enabled	154
QR Inverse	F1h 4Bh	Regular	155
MicroQR	F1h 3Dh	Enabled	155
Aztec	F1h 3Eh	Enabled	156
Aztec Inverse	F1h 4Dh	Regular	156
Symbology-Specific Security Levels			
Redundancy Level	4Eh	1	157
Security Level	4Dh	0	158
Intercharacter Gap Size	F0h 7Dh	Normal	159
Macro PDF			
Flush Macro PDF Buffer			161
Abort Macro PDF Entry			161

UPC/EAN

Enable/Disable UPC-A

Parameter # 01h

To enable or disable UPC-A, scan the appropriate bar code below.

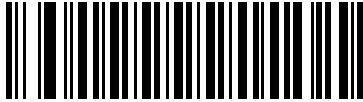

***Enable UPC-A
(01h)**

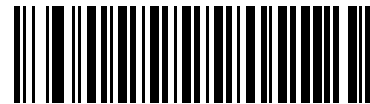

**Disable UPC-A
(00h)**

Enable/Disable UPC-E

Parameter # 02h

To enable or disable UPC-E, scan the appropriate bar code below.

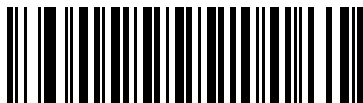

***Enable UPC-E
(01h)**



**Disable UPC-E
(00h)**

Enable/Disable UPC-E1

Parameter # 0Ch

UPC-E1 is disabled by default.

To enable or disable UPC-E1, scan the appropriate bar code below.

✓ **NOTE:** UPC-E1 is not a UCC (Uniform Code Council) approved symbology.



**Enable UPC-E1
(01h)**

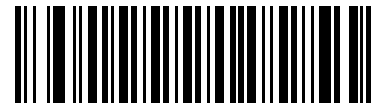

***Disable UPC-E1
(00h)**

Enable/Disable EAN-8/JAN-8

Parameter # 04h

To enable or disable EAN-8/JAN-8, scan the appropriate bar code below.

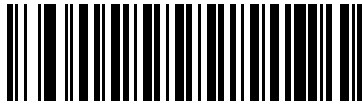

***Enable EAN-8/JAN-8
(01h)**



**Disable EAN-8/JAN-8
(00h)**

Enable/Disable EAN-13/JAN-13

Parameter # 03h

To enable or disable EAN-13/JAN-13, scan the appropriate bar code below.

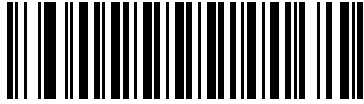

***Enable EAN-13/JAN-13**
(01h)

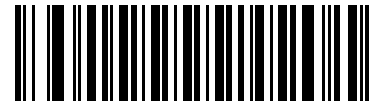

Disable EAN-13/JAN-13
(00h)

Enable/Disable Bookland EAN

Parameter # 53h

To enable or disable Bookland EAN, scan the appropriate bar code below.

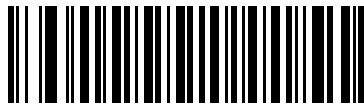

Enable Bookland EAN
(01h)

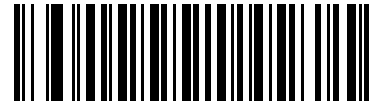

***Disable Bookland EAN**
(00h)



NOTE: If you enable Bookland EAN, select a [Bookland ISBN Format on page 104](#). Also select either Decode UPC/EAN Supplementals, Autodiscriminate UPC/EAN Supplementals, or Enable 978/979 Supplemental Mode in [Decode UPC/EAN/JAN Supplementals on page 93](#).

Decode UPC/EAN/JAN Supplementals

Parameter # 10h

Supplementals are bar codes appended according to specific format conventions (e.g., UPC A+2, UPC E+2, EAN 13+2). The following options are available:

- If you select **Ignore UPC/EAN with Supplementals**, and the digital scanner is presented with a UPC/EAN plus supplemental symbol, the scanner decodes UPC/EAN and ignores the supplemental characters.
- If you select **Decode UPC/EAN with Supplementals**, the digital scanner only decodes UPC/EAN symbols with supplemental characters, and ignores symbols without supplementals.
- If you select **Autodiscriminate UPC/EAN Supplementals**, the digital scanner decodes UPC/EAN symbols with supplemental characters immediately. If the symbol does not have a supplemental, the digital scanner must decode the bar code the number of times set via [UPC/EAN/JAN Supplemental Redundancy on page 96](#) before transmitting its data to confirm that there is no supplemental.
- If you select one of the following **Supplemental Mode** options, the digital scanner immediately transmits EAN-13 bar codes starting with that prefix that have supplemental characters. If the symbol does not have a supplemental, the digital scanner must decode the bar code the number of times set via [UPC/EAN/JAN Supplemental Redundancy on page 96](#) before transmitting its data to confirm that there is no supplemental. The digital scanner transmits UPC/EAN bar codes that do not have that prefix immediately.
 - Enable 378/379 Supplemental Mode
 - **Enable 978/979 Supplemental Mode**



NOTE: If you select 978/979 Supplemental Mode and are scanning Bookland EAN bar codes, see [Enable/Disable Bookland EAN on page 92](#) to enable Bookland EAN, and select a format using [Bookland ISBN Format on page 104](#).

- Enable 977 Supplemental Mode
- Enable 414/419/434/439 Supplemental Mode
- Enable 491 Supplemental Mode
- **Enable Smart Supplemental Mode** - applies to EAN-13 bar codes starting with any prefix listed previously.
- **Supplemental User-Programmable Type 1** - applies to EAN-13 bar codes starting with a 3-digit user-defined prefix. Set this 3-digit prefix using [User-Programmable Supplementals on page 96](#).
- **Supplemental User-Programmable Type 1 and 2** - applies to EAN-13 bar codes starting with either of two 3-digit user-defined prefixes. Set the 3-digit prefixes using [User-Programmable Supplementals on page 96](#).
- **Smart Supplemental Plus User-Programmable 1** - applies to EAN-13 bar codes starting with any prefix listed previously or the user-defined prefix set using [User-Programmable Supplementals on page 96](#).
- **Smart Supplemental Plus User-Programmable 1 and 2** - applies to EAN-13 bar codes starting with any prefix listed previously or one of the two user-defined prefixes set using [User-Programmable Supplementals on page 96](#).



NOTE: To minimize the risk of invalid data transmission, select either to decode or ignore supplemental characters.

Decode UPC/EAN/JAN Supplementals (continued)

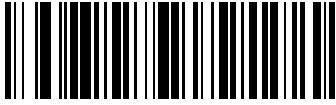

**Decode UPC/EAN/JAN Only With Supplementals
(01h)**

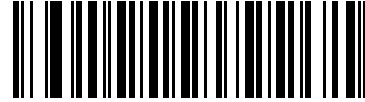

***Ignore Supplementals
(00h)**



**Autodiscriminate UPC/EAN/JAN Supplementals
(02h)**



**Enable 378/379 Supplemental Mode
(04h)**



**Enable 978/979 Supplemental Mode
(05h)**



**Enable 977 Supplemental Mode
(07h)**

Decode UPC/EAN/JAN Supplementals (continued)



**Enable 414/419/434/439 Supplemental Mode
(06h)**



**Enable 491 Supplemental Mode
(08h)**



**Enable Smart Supplemental Mode
(03h)**



**Supplemental User-Programmable Type 1
(09h)**



**Supplemental User-Programmable Type 1 and 2
(0Ah)**



**Smart Supplemental Plus User-Programmable 1
(0Bh)**



**Smart Supplemental Plus User-Programmable 1 and 2
(0Ch)**

User-Programmable Supplementals

Supplemental 1: Parameter # F1h 43h

Supplemental 2: Parameter # F1h 44h

If you selected a Supplemental User-Programmable option from [Decode UPC/EAN/JAN Supplementals on page 93](#), select **User-Programmable Supplemental 1** to set the 3-digit prefix. Then select the 3 digits using the numeric bar codes beginning on page [241](#). Select **User-Programmable Supplemental 2** to set a second 3-digit prefix. Then select the 3 digits using the numeric bar codes beginning on page [241](#).



User-Programmable Supplemental 1



User-Programmable Supplemental 2

UPC/EAN/JAN Supplemental Redundancy

Parameter # 50h

If you selected **Autodiscriminate UPC/EAN/JAN Supplementals**, this option adjusts the number of times to decode a symbol without supplementals before transmission. The range is from two to thirty times. Five or above is recommended when decoding a mix of UPC/EAN/JAN symbols with and without supplementals. The default is 10.

Scan the bar code below to set a decode redundancy value. Next, scan two numeric bar codes in [Numeric Bar Codes on page 241](#). Enter a leading zero for single digit numbers. To correct an error or change a selection, scan [Cancel on page 242](#).

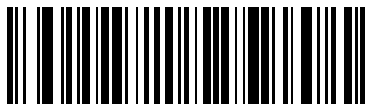

UPC/EAN/JAN Supplemental Redundancy

UPC/EAN/JAN Supplemental AIM ID Format

Parameter # F1h A0h

Select an output format when reporting UPC/EAN/JAN bar codes with supplementals with AIM ID enabled:

- Separate - UPC/EAN with supplementals transmit as]E<0 or 4><data>]E<1 or 2>[supp data]
- Combined - EAN-8 with supplementals transmit as]E4<data>]E<1 or 2>[supp data]
All other UPC/EAN with supplementals transmit as]E3<data+supps>

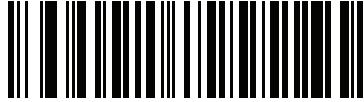

Separate
(00h)

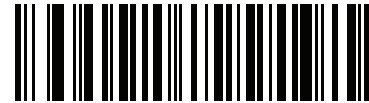

*Combined
(01h)

Transmit UPC-A Check Digit

Parameter # 28h

The check digit is the last character of the symbol used to verify the integrity of the data. Scan the appropriate bar code below to transmit the bar code data with or without the UPC-A check digit. It is always verified to guarantee the integrity of the data.

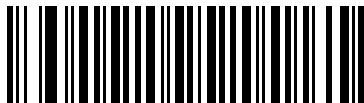

*Transmit UPC-A Check Digit
(01h)

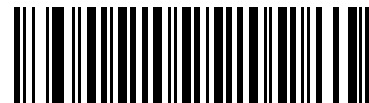

Do Not Transmit UPC-A Check Digit
(00h)

Transmit UPC-E Check Digit

Parameter # 29h

The check digit is the last character of the symbol used to verify the integrity of the data. Scan the appropriate bar code below to transmit the bar code data with or without the UPC-E check digit. It is always verified to guarantee the integrity of the data.

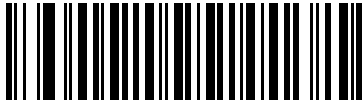

*Transmit UPC-E Check Digit
(01h)

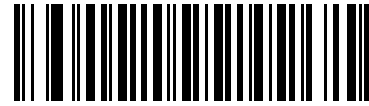

Do Not Transmit UPC-E Check Digit
(00h)

Transmit UPC-E1 Check Digit

Parameter # 2Ah

The check digit is the last character of the symbol used to verify the integrity of the data. Scan the appropriate bar code below to transmit the bar code data with or without the UPC-E1 check digit. It is always verified to guarantee the integrity of the data.

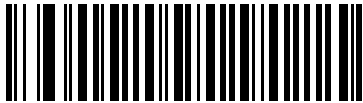

*Transmit UPC-E1 Check Digit
(01h)

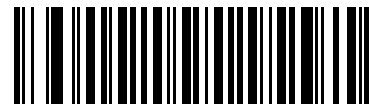

Do Not Transmit UPC-E1 Check Digit
(00h)

UPC-A Preamble

Parameter # 22h

Preamble characters are part of the UPC symbol, and include Country Code and System Character. There are three options for transmitting a UPC-A preamble to the host device: transmit System Character only, transmit

System Character and Country Code (“0” for USA), and transmit no preamble. Select the appropriate option to match the host system.



No Preamble (<DATA>)
(00h)

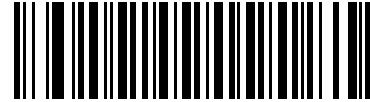

*System Character (<SYSTEM CHARACTER> <DATA>)
(01h)

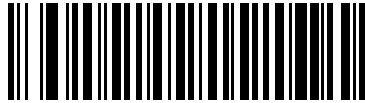

System Character & Country Code
(< COUNTRY CODE> <SYSTEM CHARACTER> <DATA>)
(02h)

UPC-E Preamble

Parameter # 23h

Preamble characters are part of the UPC symbol, and include Country Code and System Character. There are three options for transmitting a UPC-E preamble to the host device: transmit System Character only, transmit

System Character and Country Code (“0” for USA), and transmit no preamble. Select the appropriate option to match the host system.



No Preamble (<DATA>)
(00h)

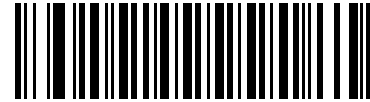

*System Character (<SYSTEM CHARACTER> <DATA>)
(01h)

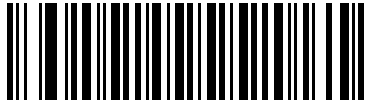

System Character & Country Code
(< COUNTRY CODE> <SYSTEM CHARACTER> <DATA>)
(02h)

UPC-E1 Preamble

Parameter # 24h

Preamble characters are part of the UPC symbol, and include Country Code and System Character. There are three options for transmitting a UPC-E1 preamble to the host device: transmit System Character only, transmit

System Character and Country Code (“0” for USA), and transmit no preamble. Select the appropriate option to match the host system.

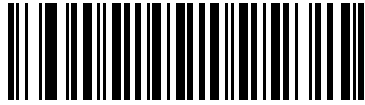

No Preamble (<DATA>)
(00h)

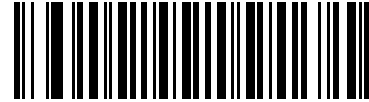

*System Character (<SYSTEM CHARACTER> <DATA>)
(01h)

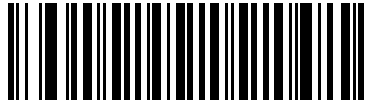

System Character & Country Code
(< COUNTRY CODE> <SYSTEM CHARACTER> <DATA>)
(02h)

Convert UPC-E to UPC-A

Parameter # 25h

Enable this to convert UPC-E (zero suppressed) decoded data to UPC-A format before transmission. After conversion, the data follows UPC-A format and is affected by UPC-A programming selections (e.g., Preamble, Check Digit).

Disable this to transmit UPC-E decoded data as UPC-E data, without conversion.

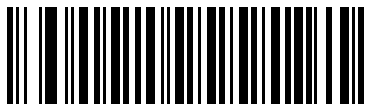

Convert UPC-E to UPC-A (Enable)
(01h)

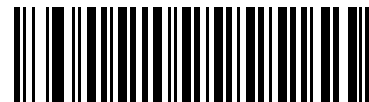

*Do Not Convert UPC-E to UPC-A (Disable)
(00h)

Convert UPC-E1 to UPC-A

Parameter # 26h

Enable this to convert UPC-E1 decoded data to UPC-A format before transmission. After conversion, the data follows UPC-A format and is affected by UPC-A programming selections (e.g., Preamble, Check Digit).

Disable this to transmit UPC-E1 decoded data as UPC-E1 data, without conversion.



Convert UPC-E1 to UPC-A (Enable)
(01h)

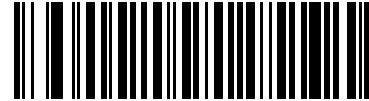

***Do Not Convert UPC-E1 to UPC-A (Disable)**
(00h)

EAN-8/JAN-8 Extend

Parameter # 27h

Enable this parameter to add five leading zeros to decoded EAN-8 symbols to make them compatible in format to EAN-13 symbols.

Disable this to transmit EAN-8 symbols as is.

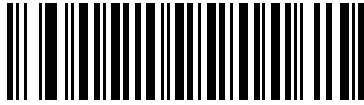

**Enable EAN/JAN Zero Extend
(01h)**

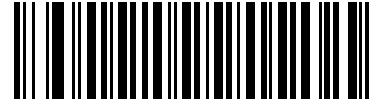

***Disable EAN/JAN Zero Extend
(00h)**

Bookland ISBN Format

Parameter # F1h 40h

If you enabled Bookland EAN using [Enable/Disable Bookland EAN on page 92](#), select one of the following formats for Bookland data:

- **Bookland ISBN-10** - The digital scanner reports Bookland data starting with 978 in traditional 10-digit format with the special Bookland check digit for backward-compatibility. Data starting with 979 is not considered Bookland in this mode.
- **Bookland ISBN-13** - The digital scanner reports Bookland data (starting with either 978 or 979) as EAN-13 in 13-digit format to meet the 2007 ISBN-13 protocol.



***Bookland ISBN-10**
(00h)



Bookland ISBN-13
(01h)



NOTE: For Bookland EAN to function properly, first enable Bookland EAN using [Enable/Disable Bookland EAN on page 92](#), then select either Decode UPC/EAN Supplementals, Autodiscriminate UPC/EAN Supplementals, or Enable 978/979 Supplemental Mode in [Decode UPC/EAN/JAN Supplementals on page 93](#).

UCC Coupon Extended Code

Parameter # 55h

Enable this parameter to decode UPC-A bar codes starting with digit '5', EAN-13 bar codes starting with digit '99', and UPC-A/GS1-128 Coupon Codes. UPCA, EAN-13, and GS1-128 must be enabled to scan all types of Coupon Codes.

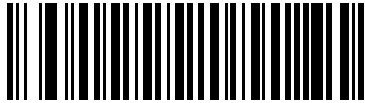

Enable UCC Coupon Extended Code
(01h)

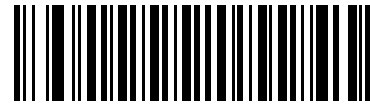

*Disable UCC Coupon Extended Code
(00h)



NOTE: See [UPC/EAN/JAN Supplemental Redundancy on page 96](#) to control autodiscrimination of the GS1-128 (right half) of a coupon code.

ISSN EAN

Parameter # F1h 69h

To enable or disable ISSN EAN, scan the appropriate bar code below.



Enable ISSN EAN
(01h)



*Disable ISSN EAN
(00h)

Code 128

Enable/Disable Code 128

Parameter # 08h

To enable or disable Code 128, scan the appropriate bar code below.

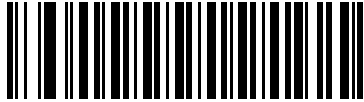

*Enable Code 128
(01h)

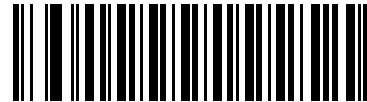

Disable Code 128
(00h)

Set Lengths for Code 128

Parameter # L1 = D1h, L2 = D2h

The length of a code refers to the number of characters (i.e., human readable characters), including check digit(s) the code contains. Set lengths for Code 128 to any length, one or two discrete lengths, or lengths within a specific range.



NOTE: When setting lengths for different bar code types, enter a leading zero for single digit numbers.

- **One Discrete Length** - Select this option to decode only Code 128 symbols containing a selected length. Select the length using the numeric bar codes in [Numeric Bar Codes on page 241](#). For example, to decode only Code 128 symbols with 14 characters, scan **Code 128 - One Discrete Length**, then scan **1** followed by **4**. To correct an error or change the selection, scan [Cancel on page 242](#).
- **Two Discrete Lengths** - Select this option to decode only Code 128 symbols containing either of two selected lengths. Select lengths using the numeric bar codes in [Numeric Bar Codes on page 241](#). For example, to decode only Code 128 symbols containing either 2 or 14 characters, select **Code 128 - Two Discrete Lengths**, then scan **0, 2, 1**, and then **4**. To correct an error or change the selection, scan [Cancel on page 242](#).
- **Length Within Range** - Select this option to decode a Code 128 symbol with a specific length range. Select lengths using numeric bar codes in [Numeric Bar Codes on page 241](#). For example, to decode Code 128 symbols containing between 4 and 12 characters, first scan **Code 128 - Length Within Range**. Then scan **0, 4, 1**, and **2** (enter a leading zero for single digit numbers). To correct an error or change the selection, scan [Cancel on page 242](#).
- **Any Length** - Select this option to decode Code 128 symbols containing any number of characters within the digital scanner's capability.

Set Lengths for Code 128 (continued)

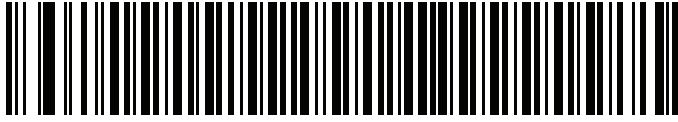

Code 128 - One Discrete Length

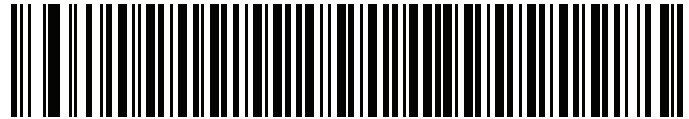

Code 128 - Two Discrete Lengths

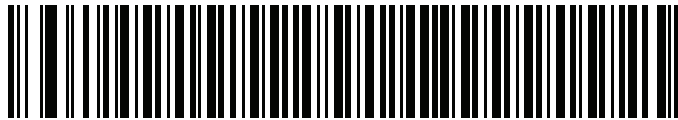

Code 128 - Length Within Range

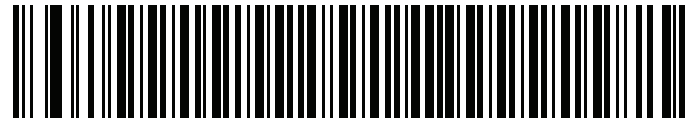

*Code 128 - Any Length

Enable/Disable GS1-128 (formerly UCC/EAN-128)

Parameter # 0Eh

To enable or disable GS1-128, scan the appropriate bar code below.

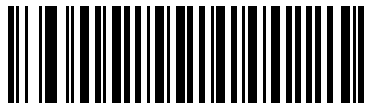

*Enable GS1-128
(01h)



Disable GS1-128
(00h)

Enable/Disable ISBT 128

Parameter # 54h

ISBT 128 is a variant of Code 128 used in the blood bank industry. Scan a bar code below to enable or disable ISBT 128. If necessary, the host must perform concatenation of the ISBT data.



***Enable ISBT 128**
(01h)



Disable ISBT 128
(00h)

ISBT Concatenation

Parameter # F1h 41h

Select an option for concatenating pairs of ISBT code types:

- If you select **Disable ISBT Concatenation**, the digital scanner does not concatenate pairs of ISBT codes it encounters.
- If you select **Enable ISBT Concatenation**, there must be two ISBT codes in order for the digital scanner to decode and perform concatenation. The digital scanner does not decode single ISBT symbols.
- If you select **Autodiscriminate ISBT Concatenation**, the digital scanner decodes and concatenates pairs of ISBT codes immediately. If only a single ISBT symbol is present, the digital scanner must decode the symbol the number of times set via [ISBT Concatenation Redundancy on page 110](#) before transmitting its data to confirm that there is no additional ISBT symbol.



*Disable ISBT Concatenation
(00h)

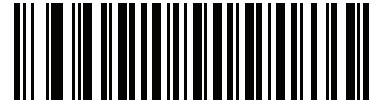

Enable ISBT Concatenation
(01h)



Autodiscriminate ISBT Concatenation
(00h)

Check ISBT Table

Parameter # F1h 42h

The ISBT specification includes a table that lists several types of ISBT bar codes that are commonly used in pairs. If you set **ISBT Concatenation** to **Enable**, enable **Check ISBT Table** to concatenate only those pairs found in this table. Other types of ISBT codes are not concatenated.



*Enable Check ISBT Table
(01h)



Disable Check ISBT Table
(00h)

ISBT Concatenation Redundancy

Parameter # DFh

If you set **ISBT Concatenation** to **Autodiscriminate**, use this parameter to set the number of times the digital scanner must decode an ISBT symbol before determining that there is no additional symbol.

Scan the bar code below, then scan two numeric bar codes in [Numeric Bar Codes on page 241](#) to set a value between 2 and 20. Enter a leading zero for single digit numbers. To correct an error or change a selection, scan [Cancel on page 242](#). The default is 10.

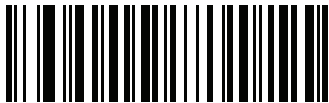

ISBT Concatenation Redundancy

Code 39

Enable/Disable Code 39

Parameter # 00h

To enable or disable Code 39, scan the appropriate bar code below.

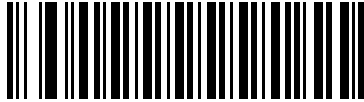

***Enable Code 39**
(01h)

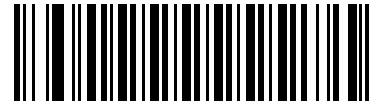

Disable Code 39
(00h)

Enable/Disable Trioptic Code 39

Parameter # 0Dh

Trioptic Code 39 is a variant of Code 39 used in the marking of computer tape cartridges. Trioptic Code 39 symbols always contain six characters. To enable or disable Trioptic Code 39, scan the appropriate bar code below.

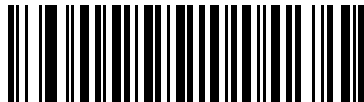

Enable Trioptic Code 39
(01h)



***Disable Trioptic Code 39**
(00h)

✓ **NOTE:** You cannot enable Trioptic Code 39 and Code 39 Full ASCII simultaneously.

Convert Code 39 to Code 32

Parameter # 56h

Code 32 is a variant of Code 39 used by the Italian pharmaceutical industry. Scan the appropriate bar code below to enable or disable converting Code 39 to Code 32.

✓ **NOTE:** Code 39 must be enabled for this parameter to function.

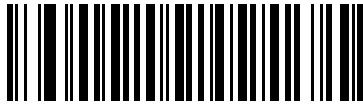

Enable Convert Code 39 to Code 32
(01h)

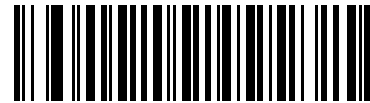

***Disable Convert Code 39 to Code 32**
(00h)

Code 32 Prefix

Parameter # E7h

Scan the appropriate bar code below to enable or disable adding the prefix character “A” to all Code 32 bar codes.

✓ **NOTE:** Convert Code 39 to Code 32 must be enabled for this parameter to function.



Enable Code 32 Prefix
(01h)



***Disable Code 32 Prefix**
(00h)

Set Lengths for Code 39

Parameter # L1 = 12h, L2 = 13h

The length of a code refers to the number of characters (i.e., human readable characters), including check digit(s) the code contains. Set lengths for Code 39 to any length, one or two discrete lengths, or lengths within a specific range. If Code 39 Full ASCII is enabled, **Length Within a Range** or **Any Length** are the preferred options.

- ✓ **NOTE:** When setting lengths for different bar code types, enter a leading zero for single digit numbers.
- **One Discrete Length** - Select this option to decode only Code 39 symbols containing a selected length. Select the length using the numeric bar codes in [Numeric Bar Codes on page 241](#). For example, to decode only Code 39 symbols with 14 characters, scan **Code 39 - One Discrete Length**, then scan **1** followed by **4**. To correct an error or change the selection, scan [Cancel on page 242](#).
 - **Two Discrete Lengths** - Select this option to decode only Code 39 symbols containing either of two selected lengths. Select lengths using the numeric bar codes in [Numeric Bar Codes on page 241](#). For example, to decode only Code 39 symbols containing either 2 or 14 characters, select **Code 39 - Two Discrete Lengths**, then scan **0, 2, 1**, and then **4**. To correct an error or change the selection, scan [Cancel on page 242](#).
 - **Length Within Range** - Select this option to decode a Code 39 symbol with a specific length range. Select lengths using numeric bar codes in [Numeric Bar Codes on page 241](#). For example, to decode Code 39 symbols containing between 4 and 12 characters, first scan **Code 39 - Length Within Range**. Then scan **0, 4, 1**, and **2** (enter a leading zero for single digit numbers). To correct an error or change the selection, scan [Cancel on page 242](#).
 - **Any Length** - Select this option to decode Code 39 symbols containing any number of characters within the digital scanner's capability.



Code 39 - One Discrete Length



Code 39 - Two Discrete Lengths



Code 39 - Length Within Range



Code 39 - Any Length

Code 39 Check Digit Verification

Parameter # 30h

Enable this feature to check the integrity of all Code 39 symbols to verify that the data complies with specified check digit algorithm. Only Code 39 symbols which include a modulo 43 check digit are decoded. Enable this feature if the Code 39 symbols contain a Modulo 43 check digit.

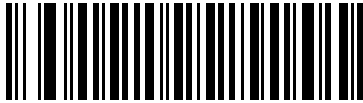

Enable Code 39 Check Digit
(01h)

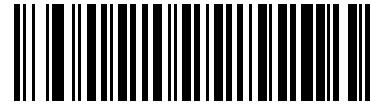

*Disable Code 39 Check Digit
(00h)

Transmit Code 39 Check Digit

Parameter # 2Bh

Scan a bar code below to transmit Code 39 data with or without the check digit.

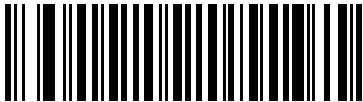

Transmit Code 39 Check Digit (Enable)
(01h)

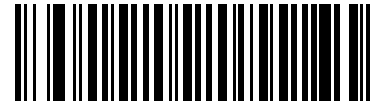

*Do Not Transmit Code 39 Check Digit (Disable)
(00h)



NOTE: Code 39 Check Digit Verification must be enabled for this parameter to function.

Code 39 Full ASCII Conversion

Parameter # 11h

Code 39 Full ASCII is a variant of Code 39 which pairs characters to encode the full ASCII character set. To enable or disable Code 39 Full ASCII, scan the appropriate bar code below.

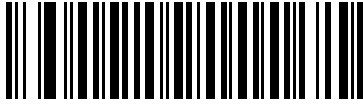

Enable Code 39 Full ASCII
(01h)

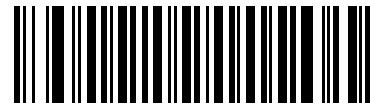

*Disable Code 39 Full ASCII
(00h)



NOTE: You cannot enable Trioptic Code 39 and Code 39 Full ASCII simultaneously.

Code 39 Full ASCII to Full ASCII Correlation is host-dependent, and is therefore described in the ASCII Character Set Table for the appropriate interface.

Code 39 Buffering - Scan & Store

Parameter # 71h

This feature allows the digital scanner to accumulate data from multiple Code 39 symbols.

Selecting the Scan and Store option (Buffer Code 39) temporarily buffers all Code 39 symbols having a leading space as a first character for later transmission. The leading space is not buffered.

Decoding a Code 39 symbol with no leading space transmits in sequence all buffered data in a first-in first-out format, plus the “triggering” symbol. See the following pages for further details.

Select **Do Not Buffer Code 39** to transmit all decoded Code 39 symbols immediately without storing them in the buffer.

Code 39 Buffering - Scan & Store (continued)

This feature affects Code 39 only. If selecting **Buffer Code 39**, we recommend configuring the digital scanner to decode Code 39 symbology only.



Buffer Code 39 (Enable)
(01h)

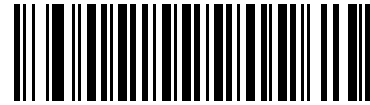

***Do Not Buffer Code 39 (Disable)**
(00h)

While there is data in the transmission buffer, you cannot select **Do Not Buffer Code 39**. The buffer holds 200 bytes of information.

To disable Code 39 buffering when there is data in the transmission buffer, first force the buffer transmission (see [Transmit Buffer on page 117](#)) or clear the buffer.

Buffer Data

To buffer data, enable Code 39 buffering and scan a Code 39 symbol with a space immediately following the start pattern.

- Unless the data overflows the transmission buffer, the digital scanner issues a low/high beep to indicate successful decode and buffering. (For overflow conditions, see [Overfilling Transmission Buffer on page 117](#).)
- The digital scanner adds the decoded data excluding the leading space to the transmission buffer.
- No transmission occurs.

Clear Transmission Buffer

To clear the transmission buffer, scan the **Clear Buffer** bar code below, which contains only a start character, a dash (minus), and a stop character.

- The digital scanner issues a short high/low/high beep.
- The digital scanner erases the transmission buffer.

- No transmission occurs.



Clear Buffer

- ✓ **NOTE:** The Clear Buffer contains only the dash (minus) character. In order to scan this command, set Code 39 lengths to include length 1.

Transmit Buffer

There are two methods to transmit the Code 39 buffer.

1. Scan the **Transmit Buffer** bar code below, which includes only a start character, a plus (+), and a stop character.
2. The digital scanner transmits and clears the buffer.
 - The digital scanner issues a low/high beep.



Transmit Buffer

3. Scan a Code 39 bar code with a leading character other than a space.
 - The digital scanner appends new decode data to buffered data.
 - The digital scanner transmits and clears the buffer.
 - The digital scanner signals that it transmitted the buffer with a low/high beep.
 - The digital scanner transmits and clears the buffer.

- ✓ **NOTE:** The Transmit Buffer contains only a plus (+) character. In order to scan this command, set Code 39 lengths to include length 1.

Overfilling Transmission Buffer

The Code 39 buffer holds 200 characters. If the symbol just read overflows the transmission buffer:

- The digital scanner indicates that it rejected the symbol by issuing three long, high beeps.
- No transmission occurs. The data in the buffer is not affected.

Attempt to Transmit an Empty Buffer

If you scan the **Transmit Buffer** symbol and the Code 39 buffer is empty:

- A short low/high/low beep signals that the buffer is empty.
- No transmission occurs.
- The buffer remains empty.

Code 93

Enable/Disable Code 93

Parameter # 09h

To enable or disable Code 93, scan the appropriate bar code below.

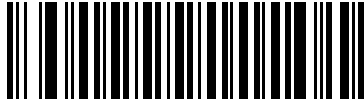

Enable Code 93
(01h)

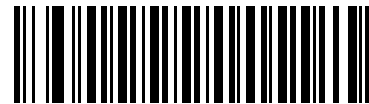

*Disable Code 93
(00h)

Set Lengths for Code 93

Parameter # L1 = 1Ah, L2 = 1Bh

The length of a code refers to the number of characters (i.e., human readable characters), including check digit(s) the code contains. Set lengths for Code 93 to any length, one or two discrete lengths, or lengths within a specific range.

- **One Discrete Length** - Select this option to decode only Code 93 symbols containing a selected length. Select the length using the numeric bar codes in [Numeric Bar Codes on page 241](#). For example, to decode only Code 93 symbols with 14 characters, scan **Code 93 - One Discrete Length**, then scan **1** followed by **4**. To correct an error or to change the selection, scan [Cancel on page 242](#).
- **Two Discrete Lengths** - Select this option to decode only Code 93 symbols containing either of two selected lengths. Select lengths using the numeric bar codes in [Numeric Bar Codes on page 241](#). For example, to decode only Code 93 symbols containing either 2 or 14 characters, select **Code 93 - Two Discrete Lengths**, then scan **0, 2, 1**, and then **4**. To correct an error or to change the selection, scan [Cancel on page 242](#).
- **Length Within Range** - Select this option to decode a Code 93 symbol with a specific length range. Select lengths using the numeric bar codes in [Numeric Bar Codes on page 241](#). For example, to decode Code 93 symbols containing between 4 and 12 characters, first scan **Code 93 - Length Within Range**. Then scan **0, 4, 1**, and **2** (enter a leading zero for single digit numbers). To correct an error or change the selection, scan [Cancel on page 242](#).
- **Any Length** - Scan this option to decode Code 93 symbols containing any number of characters within the digital scanner's capability.

Set Lengths for Code 93 (continued)



Code 93 - One Discrete Length



Code 93 - Two Discrete Lengths



Code 93 - Length Within Range



Code 93 - Any Length

Code 11

Code 11

Parameter # 0Ah

To enable or disable Code 11, scan the appropriate bar code below.

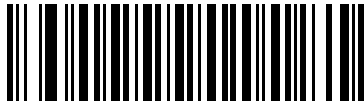

Enable Code 11
(01h)

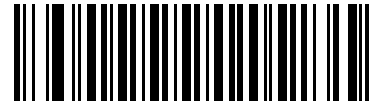

*Disable Code 11
(00h)

Set Lengths for Code 11

Parameter # L1 = 1Ch, L2 = 1Dh

The length of a code refers to the number of characters (i.e., human readable characters), including check digit(s) the code contains. Set lengths for Code 11 to any length, one or two discrete lengths, or lengths within a specific range.

- **One Discrete Length** - Select this option to decode only Code 11 symbols containing a selected length. Select the length using the numeric bar codes in [Numeric Bar Codes on page 241](#). For example, to decode only Code 11 symbols with 14 characters, scan **Code 11 - One Discrete Length**, then scan **1** followed by **4**. To correct an error or to change the selection, scan [Cancel on page 242](#).
- **Two Discrete Lengths** - Select this option to decode only Code 11 symbols containing either of two selected lengths. Select lengths using the numeric bar codes in [Numeric Bar Codes on page 241](#). For example, to decode only Code 11 symbols containing either 2 or 14 characters, select **Code 11 - Two Discrete Lengths**, then scan **0, 2, 1**, and then **4**. To correct an error or to change the selection, scan [Cancel on page 242](#).
- **Length Within Range** - Select this option to decode a Code 11 symbol with a specific length range. Select lengths using numeric bar codes in [Numeric Bar Codes on page 241](#). For example, to decode Code 11 symbols containing between 4 and 12 characters, first scan **Code 11 - Length Within Range**. Then scan **0, 4, 1**, and **2** (enter a leading zero for single digit numbers). To correct an error or change the selection, scan [Cancel on page 242](#).
- **Any Length** - Scan this option to decode Code 11 symbols containing any number of characters within the digital scanner's capability.

Set Lengths for Code 11 (continued)



Code 11 - One Discrete Length



Code 11 - Two Discrete Lengths



Code 11 - Length Within Range



Code 11 - Any Length

Code 11 Check Digit Verification

Parameter # 34h

This feature allows the digital scanner to check the integrity of all Code 11 symbols to verify that the data complies with the specified check digit algorithm. This selects the check digit mechanism for the decoded Code 11 bar code. The options are to check for one check digit, check for two check digits, or disable the feature.

Symbologies

To enable this feature, scan the bar code below corresponding to the number of check digits encoded in the Code 11 symbols.

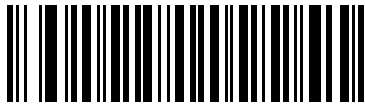

***Disable
(00h)**

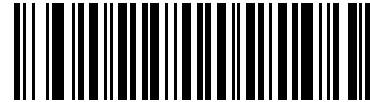

**One Check Digit
(01h)**

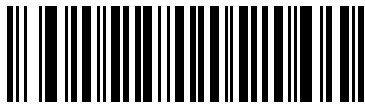

**Two Check Digits
(02h)**

Transmit Code 11 Check Digits

Parameter # 2Fh

This feature selects whether or not to transmit the Code 11 check digit(s).

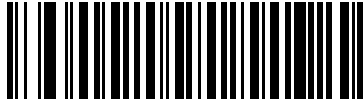

Transmit Code 11 Check Digit(s) (Enable)
(01h)



***Do Not Transmit Code 11 Check Digit(s) (Disable)**
(00h)

✓ **NOTE:** Code 11 Check Digit Verification must be enabled for this parameter to function.

Interleaved 2 of 5 (ITF)

Enable/Disable Interleaved 2 of 5

Parameter # 06h

To enable or disable Interleaved 2 of 5, scan the appropriate bar code below, and select an Interleaved 2 of 5 length from the following pages.

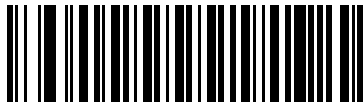

***Enable Interleaved 2 of 5**
(01h)

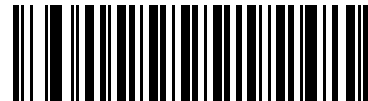

Disable Interleaved 2 of 5
(00h)

Set Lengths for Interleaved 2 of 5

Parameter # L1 = 16h, L2 = 17h

The length of a code refers to the number of characters (i.e., human readable characters), including check digit(s) the code contains. Set lengths for I 2 of 5 to any length, one or two discrete lengths, or lengths within a specific range. The range for Interleaved 2 of 5 lengths is 0 - 55.

- **One Discrete Length** - Select this option to decode only I 2 of 5 symbols containing a selected length. Select the length using the numeric bar codes in [Numeric Bar Codes on page 241](#). For example, to decode only I 2 of 5 symbols with 14 characters, scan **I 2 of 5 - One Discrete Length**, then scan **1** followed by **4**. To correct an error or to change the selection, scan [Cancel on page 242](#).
- **Two Discrete Lengths** - Select this option to decode only I 2 of 5 symbols containing either of two selected lengths. Select lengths using the numeric bar codes in [Numeric Bar Codes on page 241](#). For example, to decode only I 2 of 5 symbols containing either 2 or 14 characters, select **I 2 of 5 - Two Discrete Lengths**, then scan **0, 2, 1**, and then **4**. To correct an error or to change the selection, scan [Cancel on page 242](#).
- **Length Within Range** - Select this option to decode an I 2 of 5 symbol with a specific length range. Select lengths using numeric bar codes in [Numeric Bar Codes on page 241](#). For example, to decode I 2 of 5 symbols containing between 4 and 12 characters, first scan **I 2 of 5 - Length Within Range**. Then scan **0, 4, 1**, and **2** (enter a leading zero for single digit numbers). To correct an error or change the selection, scan [Cancel on page 242](#).
- **Any Length** - Scan this option to decode I 2 of 5 symbols containing any number of characters within the digital scanner's capability.

✓ **NOTE:** Due to the construction of the I 2 of 5 symbology, it is possible for a scan line covering only a portion of the code to transmit as a complete scan, yielding less data than is encoded in the bar code. To prevent this, select specific lengths (I 2 of 5 - One Discrete Length, Two Discrete Lengths) for I 2 of 5 applications.

Set Lengths for Interleaved 2 of 5 (continued)



I 2 of 5 - One Discrete Length



I 2 of 5 - Two Discrete Lengths



I 2 of 5 - Length Within Range



I 2 of 5 - Any Length

I 2 of 5 Check Digit Verification

Parameter # 31h

Enable this feature to check the integrity of all I 2 of 5 symbols to verify the data complies with either the specified Uniform Symbology Specification (USS), or the Optical Product Code Council (OPCC) check digit algorithm.



***Disable
(00h)**



**USS Check Digit
(01h)**



**OPCC Check Digit
(02h)**

Transmit I 2 of 5 Check Digit

Parameter # 2Ch

Scan the appropriate bar code below to transmit I 2 of 5 data with or without the check digit.

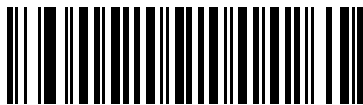

**Transmit I 2 of 5 Check Digit (Enable)
(01h)**

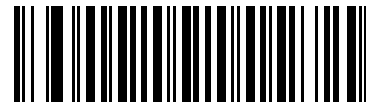

***Do Not Transmit I 2 of 5 Check Digit (Disable)
(00h)**

Convert I 2 of 5 to EAN-13

Parameter # 52h

Enable this parameter to convert 14-character I 2 of 5 codes to EAN-13, and transmit to the host as EAN-13. To accomplish this, the I 2 of 5 code must be enabled, and the code must have a leading zero and a valid EAN-13 check digit.

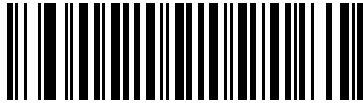

Convert I 2 of 5 to EAN-13 (Enable)
(01h)

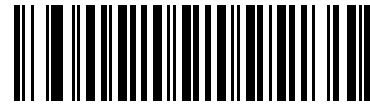

*Do Not Convert I 2 of 5 to EAN-13 (Disable)
(00h)

Discrete 2 of 5 (DTF)

Enable/Disable Discrete 2 of 5

Parameter # 05h

To enable or disable Discrete 2 of 5, scan the appropriate bar code below.



Enable Discrete 2 of 5
(01h)



*Disable Discrete 2 of 5
(00h)

Set Lengths for Discrete 2 of 5

Parameter # L1 = 14h, L2 = 15h

The length of a code refers to the number of characters (i.e., human readable characters), including check digit(s) the code contains. Set lengths for D 2 of 5 to any length, one or two discrete lengths, or lengths within a specific range. The range for Discrete 2 of 5 lengths is 0 - 55.

- **One Discrete Length** - Select this option to decode only D 2 of 5 symbols containing a selected length. Select the length using the numeric bar codes in [Numeric Bar Codes on page 241](#). For example, to decode only D 2 of 5 symbols with 14 characters, scan **D 2 of 5 - One Discrete Length**, then scan **1** followed by **4**. To correct an error or to change the selection, scan [Cancel on page 242](#).
- **Two Discrete Lengths** - Select this option to decode only D 2 of 5 symbols containing either of two selected lengths. Select lengths using the numeric bar codes in [Numeric Bar Codes on page 241](#). For example, to decode only D 2 of 5 symbols containing either 2 or 14 characters, select **D 2 of 5 - Two Discrete Lengths**, then scan **0, 2, 1**, and then **4**. To correct an error or to change the selection, scan [Cancel on page 242](#).
- **Length Within Range** - Select this option to decode a D 2 of 5 symbol with a specific length range. Select lengths using numeric bar codes in [Numeric Bar Codes on page 241](#). For example, to decode D 2 of 5 symbols containing between 4 and 12 characters, first scan **D 2 of 5 - Length Within Range**. Then scan **0, 4, 1**, and **2** (enter a leading zero for single digit numbers). To correct an error or change the selection, scan [Cancel on page 242](#).
- **Any Length** - Scan this option to decode D 2 of 5 symbols containing any number of characters within the digital scanner's capability.



NOTE: Due to the construction of the D 2 of 5 symbology, it is possible for a scan line covering only a portion of the code to transmit as a complete scan, yielding less data than is encoded in the bar code. To prevent this, select specific lengths (**D 2 of 5 - One Discrete Length, Two Discrete Lengths**) for D 2 of 5 applications.

Set Lengths for Discrete 2 of 5 (continued)



D 2 of 5 - One Discrete Length



D 2 of 5 - Two Discrete Lengths



D 2 of 5 - Length Within Range



D 2 of 5 - Any Length

Codabar (NW - 7)

Enable/Disable Codabar

Parameter # 07h

To enable or disable Codabar, scan the appropriate bar code below.

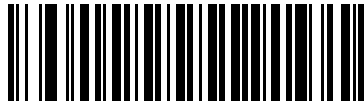

Enable Codabar
(01h)

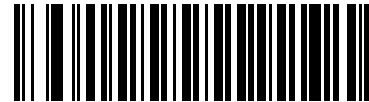

*Disable Codabar
(00h)

Set Lengths for Codabar

Parameter # L1 = 18h, L2 = 19h

The length of a code refers to the number of characters (i.e., human readable characters), including check digit(s) the code contains. Set lengths for Codabar to any length, one or two discrete lengths, or lengths within a specific range.

- **One Discrete Length** - Select this option to decode only Codabar symbols containing a selected length. Select the length using the numeric bar codes in [Numeric Bar Codes on page 241](#). For example, to decode only Codabar symbols with 14 characters, scan **Codabar - One Discrete Length**, then scan **1** followed by **4**. To correct an error or to change the selection, scan [Cancel on page 242](#).
- **Two Discrete Lengths** - Select this option to decode only Codabar symbols containing either of two selected lengths. Select lengths using the numeric bar codes in [Numeric Bar Codes on page 241](#). For example, to decode only Codabar symbols containing either 2 or 14 characters, select **Codabar - Two Discrete Lengths**, then scan **0**, **2**, **1**, and then **4**. To correct an error or to change the selection, scan [Cancel on page 242](#).
- **Length Within Range** - Select this option to decode a Codabar symbol with a specific length range. Select lengths using numeric bar codes in [Numeric Bar Codes on page 241](#). For example, to decode Codabar symbols containing between 4 and 12 characters, first scan **Codabar - Length Within Range**. Then scan **0**, **4**, **1**, and **2** (enter a leading zero for single digit numbers). To correct an error or change the selection, scan [Cancel on page 242](#).
- **Any Length** - Scan this option to decode Codabar symbols containing any number of characters within the digital scanner's capability.

Set Lengths for Codabar (continued)



Codabar - One Discrete Length



Codabar - Two Discrete Lengths



Codabar - Length Within Range



Codabar - Any Length

CLSI Editing

Parameter # 36h

Enable this parameter to strip the start and stop characters and insert a space after the first, fifth, and tenth characters of a 14-character Codabar symbol. Enable this feature if the host system requires this data format.



NOTE: Symbol length does not include start and stop characters.



**Enable CLSI Editing
(01h)**

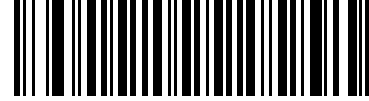

***Disable CLSI Editing
(00h)**

NOTIS Editing

Parameter # 37h

Enable this parameter to strip the start and stop characters from a decoded Codabar symbol. Enable this feature if the host system requires this data format.

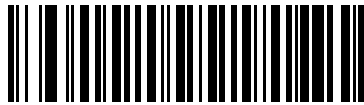

**Enable NOTIS Editing
(01h)**

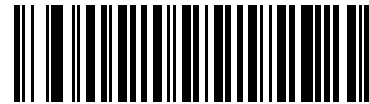

***Disable NOTIS Editing
(00h)**

MSI

Enable/Disable MSI

Parameter # 0Bh

To enable or disable MSI, scan the appropriate bar code below.

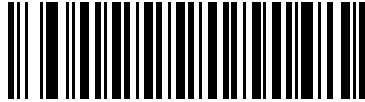

Enable MSI
(01h)

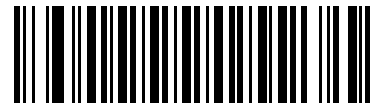

*Disable MSI
(00h)

Set Lengths for MSI

Parameter # L1 = 1Eh, L2 = 1Fh

The length of a code refers to the number of characters (i.e., human readable characters), including check digit(s) the code contains. Set lengths for MSI to any length, one or two discrete lengths, or lengths within a specific range.

- **One Discrete Length** - Select this option to decode only MSI symbols containing a selected length. Select the length using the numeric bar codes in [Numeric Bar Codes on page 241](#). For example, to decode only MSI symbols with 14 characters, scan **MSI - One Discrete Length**, then scan **1** followed by **4**. To correct an error or to change the selection, scan [Cancel on page 242](#).
- **Two Discrete Lengths** - Select this option to decode only MSI symbols containing either of two selected lengths. Select lengths using the numeric bar codes in [Numeric Bar Codes on page 241](#). For example, to decode only MSI symbols containing either 2 or 14 characters, select **MSI - Two Discrete Lengths**, then scan **0**, **2**, **1**, and then **4**. To correct an error or to change the selection, scan [Cancel on page 242](#).
- **Length Within Range** - Select this option to decode a MSI symbol with a specific length range. Select lengths using numeric bar codes in [Numeric Bar Codes on page 241](#). For example, to decode MSI symbols containing between 4 and 12 characters, first scan **MSI - Length Within Range**. Then scan **0**, **4**, **1**, and **2** (enter a leading zero for single digit numbers). To correct an error or change the selection, scan [Cancel on page 242](#).
- **Any Length** - Scan this option to decode MSI symbols containing any number of characters within the digital scanner's capability.

Set Lengths for MSI (continued)



NOTE: Due to the construction of the MSI symbology, it is possible for a scan line covering only a portion of the code to transmit as a complete scan, yielding less data than is encoded in the bar code. To prevent this, select specific lengths (**MSI - One Discrete Length, Two Discrete Lengths**) for MSI applications.

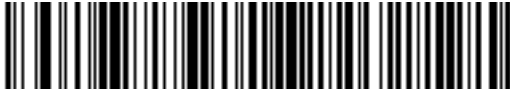

MSI - One Discrete Length



MSI - Two Discrete Lengths



MSI - Length Within Range



MSI - Any Length

MSI Check Digits

Parameter # 32h

With MSI symbols, one check digit is mandatory and always verified by the reader. The second check digit is optional. If the MSI codes include two check digits, scan the **Two MSI Check Digits** bar code to enable verification of the second check digit.

See [MSI Check Digit Algorithm on page 136](#) for the selection of second digit algorithms.



***One MSI Check Digit
(00h)**

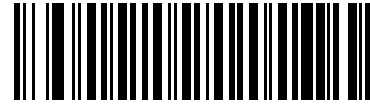

**Two MSI Check Digits
(01h)**

Transmit MSI Check Digit(s)

Parameter # 2Eh

Scan a bar code below to transmit MSI data with or without the check digit.

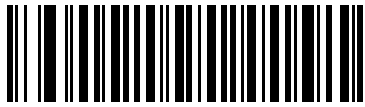

**Transmit MSI Check Digit(s) (Enable)
(01h)**

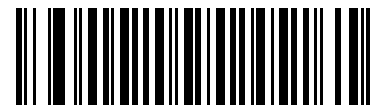

***Do Not Transmit MSI Check Digit(s) (Disable)
(00h)**

MSI Check Digit Algorithm

Parameter # 33h

Two algorithms are possible for the verification of the second MSI check digit. Select the bar code below corresponding to the algorithm used to encode the check digit.



**MOD 10/MOD 11
(00h)**



***MOD 10/MOD 10
(01h)**

Chinese 2 of 5

Enable/Disable Chinese 2 of 5

Parameter # F0h 98h

To enable or disable Chinese 2 of 5, scan the appropriate bar code below.



**Enable Chinese 2 of 5
(01h)**



***Disable Chinese 2 of 5
(00h)**

Matrix 2 of 5

Enable/Disable Matrix 2 of 5

Parameter # F1h 6Ah

To enable or disable Matrix 2 of 5, scan the appropriate bar code below.



**Enable Matrix 2 of 5
(01h)**

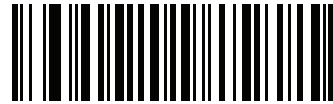

***Disable Matrix 2 of 5
(00h)**

Set Lengths for Matrix 2 of 5

Parameter # L1 = F1h 6Bh, L2 = F1h 6Ch

The length of a code refers to the number of characters (i.e., human readable characters), including check digit(s) the code contains. Set lengths for Matrix 2 of 5 to any length, one or two discrete lengths, or lengths within a specific range.

- **One Discrete Length** - Select this option to decode only Matrix 2 of 5 symbols containing a selected length. Select the length using the numeric bar codes in [Numeric Bar Codes on page 241](#). For example, to decode only Matrix 2 of 5 symbols with 14 characters, scan **Matrix 2 of 5 - One Discrete Length**, then scan **1** followed by **4**. To correct an error or to change the selection, scan [Cancel on page 242](#).
- **Two Discrete Lengths** - Select this option to decode only Matrix 2 of 5 symbols containing either of two selected lengths. Select lengths using the numeric bar codes in [Numeric Bar Codes on page 241](#). For example, to decode only Matrix 2 of 5 symbols containing either 2 or 14 characters, select **Matrix 2 of 5 - Two Discrete Lengths**, then scan **0**, **2**, **1**, and then **4**. To correct an error or to change the selection, scan [Cancel on page 242](#).
- **Length Within Range** - Select this option to decode a Matrix 2 of 5 symbol with a specific length range. Select lengths using the numeric bar codes in [Numeric Bar Codes on page 241](#). For example, to decode Matrix 2 of 5 symbols containing between 4 and 12 characters, first scan **Matrix 2 of 5 - Length Within Range**. Then scan **0**, **4**, **1**, and **2** (enter a leading zero for single digit numbers). To correct an error or change the selection, scan [Cancel on page 242](#).
- **Any Length** - Scan this option to decode Matrix 2 of 5 symbols containing any number of characters within the digital scanner's capability.



*Matrix 2 of 5 - One Discrete Length



Matrix 2 of 5 - Two Discrete Lengths



Matrix 2 of 5 - Length Within Range



Matrix 2 of 5 - Any Length

Matrix 2 of 5 Redundancy

Parameter # F1h 6Dh

To enable or disable Matrix 2 of 5 redundancy, scan the appropriate bar code below.



**Enable Matrix 2 of 5 Redundancy
(01h)**



***Disable Matrix 2 of 5 Redundancy
(00h)**

Matrix 2 of 5 Check Digit

Parameter # F1h 6Eh

The check digit is the last character of the symbol used to verify the integrity of the data. Scan the appropriate bar code below to transmit the bar code data with or without the Matrix 2 of 5 check digit.



**Enable Matrix 2 of 5 Check Digit
(01h)**

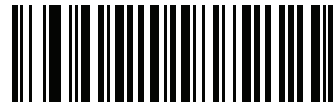

***Disable Matrix 2 of 5 Check Digit
(00h)**

Transmit Matrix 2 of 5 Check Digit

Parameter # F1h 6Fh

Scan a bar code below to transmit Matrix 2 of 5 data with or without the check digit.



Transmit Matrix 2 of 5 Check Digit
(01h)



*Do Not Transmit Matrix 2 of 5 Check Digit
(00h)

Inverse 1D

Parameter # F1h 4Ah

This parameter sets the 1D inverse decoder setting. Options are:

- **Regular Only** - the digital scanner decodes regular 1D bar codes only.
- **Inverse Only** - the digital scanner decodes inverse 1D bar codes only.
- **Inverse Autodetect** - the digital scanner decodes both regular and inverse 1D bar codes.



*Regular
(00h)



Inverse Only
(01h)



Inverse Autodetect
(02h)

Postal Codes

US Postnet

Parameter # 59h

To enable or disable US Postnet, scan the appropriate bar code below.



Enable US Postnet
(01h)



*Disable US Postnet
(00h)

US Planet

Parameter # 5Ah

To enable or disable US Planet, scan the appropriate bar code below.



Enable US Planet
(01h)



*Disable US Planet
(00h)

Transmit US Postal Check Digit

Parameter # 5Fh

Select whether to transmit US Postal data, which includes both US Postnet and US Planet, with or without the check digit.



***Transmit US Postal Check Digit
(01h)**

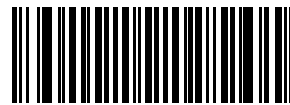

**Do Not Transmit US Postal Check Digit
(00h)**

UK Postal

Parameter # 5Bh

To enable or disable UK Postal, scan the appropriate bar code below.



**Enable UK Postal
(01h)**



***Disable UK Postal
(00h)**

Transmit UK Postal Check Digit

Parameter # 60h

Select whether to transmit UK Postal data with or without the check digit.



***Transmit UK Postal
Check Digit
(01h)**



**Do Not Transmit UK Postal Check Digit
(00h)**

Japan Postal

Parameter # F0h, 22h

To enable or disable Japan Postal, scan the appropriate bar code below.



**Enable Japan Postal
(01h)**



***Disable Japan Postal
(00h)**

Australian Postal

Parameter # F0h, 23h

To enable or disable Australian Postal, scan the appropriate bar code below.



**Enable Australian Postal
(01h)**



***Disable Australian Postal
(00h)**

Netherlands KIX Code

Parameter # F0h, 46h

To enable or disable Netherlands KIX Code, scan the appropriate bar code below.



**Enable Netherlands KIX Code
(01h)**



***Disable Netherlands KIX Code
(00h)**

USPS 4CB/One Code/Intelligent Mail

Parameter # F1h 50h

To enable or disable USPS 4CB/One Code/Intelligent Mail, scan the appropriate bar code below.



Enable USPS 4CB/One Code/Intelligent Mail
(01h)



*Disable USPS 4CB/One Code/Intelligent Mail
(00h)

UPU FICS Postal

Parameter # F1h 63h

To enable or disable UPU FICS Postal, scan the appropriate bar code below.



Enable UPU FICS Postal
(01h)



*Disable UPU FICS Postal
(00h)

Mailmark

Mailmark is always enabled.

GS1 DataBar

The variants of GS1 DataBar are DataBar-14, DataBar Expanded, and DataBar Limited. The limited and expanded versions have stacked variants. Scan the appropriate bar codes to enable or disable each variant of GS1 DataBar.

GS1 DataBar-14

Parameter # F0h 52h.



Enable GS1 DataBar-14
(01h)

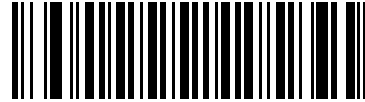

*Disable GS1 DataBar 14
(00h)

GS1 DataBar Limited

Parameter # F0h 53h.

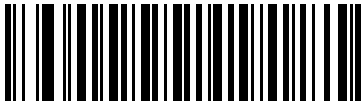

Enable GS1 DataBar Limited
(01h)

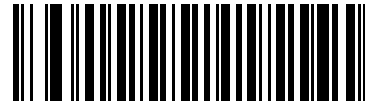

*Disable GS1 DataBar Limited
(00h)

GS1 DataBar Expanded**Parameter # F0h 54h.**

**Enable GS1 DataBar Expanded
(01h)**

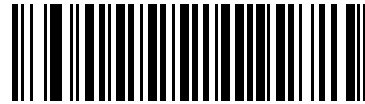

***Disable GS1 DataBar Expanded
(00h)**

Convert GS1 DataBar to UPC/EAN**Parameter # F0h, 8Dh**

This parameter only applies to GS1 DataBar-14 and GS1 DataBar Limited symbols not decoded as part of a Composite symbol. Enable this to strip the leading '010' from DataBar-14 and DataBar Limited symbols encoding a single zero as the first digit, and report the bar code as EAN-13.

For bar codes beginning with two or more zeros but not six zeros, this parameter strips the leading '0100' and reports the bar code as UPC-A. The UPC-A Preamble parameter that transmits the system character and country code applies to converted bar codes. Note that neither the system character nor the check digit can be stripped.

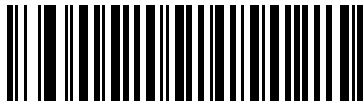

**Enable Convert GS1 DataBar to UPC/EAN
(01h)**

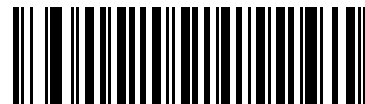

***Disable Convert GS1 DataBar to UPC/EAN
(00h)**

Composite

Composite CC-C

Parameter # F0h 55h

Scan a bar code below to enable or disable Composite bar codes of type CC-C.



Enable CC-C
(01h)

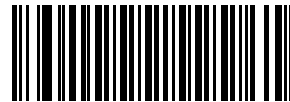

*Disable CC-C
(00h)

Composite CC-A/B

Parameter # F0h 56h

Scan a bar code below to enable or disable Composite bar codes of type CC-A/B.

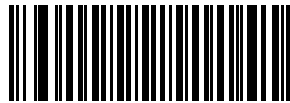

Enable CC-A/B
(01h)

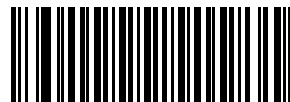

*Disable CC-A/B
(00h)

Composite TLC-39

Parameter # F0h 73h

Scan a bar code below to enable or disable Composite bar codes of type TLC-39.

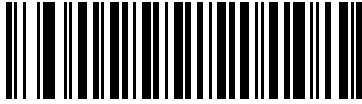

Enable TLC39
(01h)



***Disable TLC39**
(00h)

UPC Composite Mode

Parameter # F0h 58h

Select an option for linking UPC symbols with a 2D symbol during transmission as if they were one symbol:

- Select **UPC Never Linked** to transmit UPC bar codes regardless of whether a 2D symbol is detected.
- Select **UPC Always Linked** to transmit UPC bar codes and the 2D portion.
If 2D is not present, the UPC bar code does not transmit.
- If you select **Autodiscriminate UPC Composites**, the digital scanner determines if there is a 2D portion, then transmits the UPC, as well as the 2D portion if present.

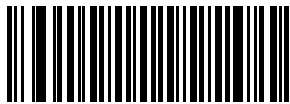

***UPC Never Linked**
(00h)

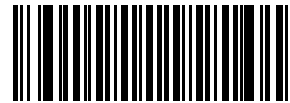

UPC Always Linked
(01h)



Autodiscriminate UPC Composites
(02h)

Composite Beep Mode

Parameter # F0h, 8Eh

To select the number of decode beeps when a composite bar code is decoded, scan the appropriate bar code.

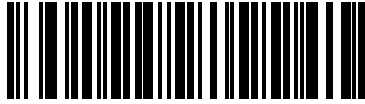

Single Beep after both are decoded
(00h)

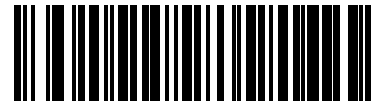

*Beep as each code type is decoded
(01h)

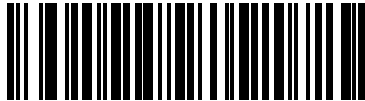

Double Beep after both are decoded
(02h)

GS1-128 Emulation Mode for UCC/EAN Composite Codes

Parameter # F0h, ABh

Select whether to enable or disable this mode.



Enable GS1-128 Emulation Mode for
UCC/EAN Composite Codes
(01h)



*Disable GS1-128 Emulation Mode for
UCC/EAN Composite Codes
(00h)

2D Symbologies

Enable/Disable PDF417

Parameter # 0Fh

To enable or disable PDF417, scan the appropriate bar code below.



***Enable PDF417
(01h)**



**Disable PDF417
(00h)**

Enable/Disable MicroPDF417

Parameter # E3h

To enable or disable MicroPDF417, scan the appropriate bar code below.



**Enable MicroPDF417
(01h)**



***Disable MicroPDF417
(00h)**

Code 128 Emulation

Parameter # 7Bh

Enable this parameter to transmit data from certain MicroPDF417 symbols as Code 128. [AIM Code ID Character \(01h\) on page 79](#) must be enabled for this parameter to work.

Enable Code 128 Emulation to transmit these MicroPDF417 symbols with one of the following prefixes:

]C1if the first codeword is 903-905

]C2if the first codeword is 908 or 909

]C0if the first codeword is 910 or 911

Disable Code 128 Emulation to transmit these MicroPDF417 symbols with one of the following prefixes:

]L3if the first codeword is 903-905

]L4if the first codeword is 908 or 909

]L5if the first codeword is 910 or 911

Scan a bar code below to enable or disable Code 128 Emulation.



NOTE: Linked MicroPDF codewords 906, 907, 912, 914, and 915 are not supported. Use GS1 Composites instead.



**Enable Code 128 Emulation
(01h)**



***Disable Code 128 Emulation
(00h)**

Data Matrix

Parameter # F0h, 24h

To enable or disable Data Matrix, scan the appropriate bar code below.



***Enable Data Matrix
(01h)**



**Disable Data Matrix
(00h)**

Data Matrix Inverse

Parameter # F1h 4Ch

This parameter sets the Data Matrix inverse decoder setting. Options are:

- **Regular Only** - the digital scanner decodes regular Data Matrix bar codes only.
- **Inverse Only** - the digital scanner decodes inverse Data Matrix bar codes only.
- **Inverse Autodetect** - the digital scanner decodes both regular and inverse Data Matrix bar codes.



***Regular
(00h)**



**Inverse Only
(01h)**



**Inverse Autodetect
(02h)**

Maxicode

Parameter # F0h, 26h

To enable or disable Maxicode, scan the appropriate bar code below.



***Enable Maxicode
(01h)**



**Disable Maxicode
(00h)**

QR Code

Parameter # F0h,25h

To enable or disable QR Code, scan the appropriate bar code below.



***Enable QR Code
(01h)**



**Disable QR Code
(00h)**

QR Inverse

Parameter # F1h 4Bh

This parameter sets the QR inverse decoder setting. Options are:

- **Regular Only** - the digital scanner decodes regular QR bar codes only.
- **Inverse Only** - the digital scanner decodes inverse QR bar codes only.
- **Inverse Autodetect** - the digital scanner decodes both regular and inverse QR bar codes.



***Regular
(00h)**



**Inverse Only
(01h)**



**Inverse Autodetect
(02h)**

MicroQR

Parameter # F1h 3Dh

To enable or disable MicroQR, scan the appropriate bar code below.



***Enable MicroQR
(01h)**



**Disable MicroQR
(00h)**

Aztec

Parameter # F1h 3Eh

To enable or disable Aztec, scan the appropriate bar code below.



***Enable Aztec
(01h)**



**Disable Aztec
(00h)**

Aztec Inverse

Parameter # F1h 4Dh

This parameter sets the Aztec inverse decoder setting. Options are:

- **Regular Only** - the digital scanner decodes regular Aztec bar codes only.
- **Inverse Only** - the digital scanner decodes inverse Aztec bar codes only.
- **Inverse Autodetect** - the digital scanner decodes both regular and inverse Aztec bar codes.



***Regular
(00h)**



**Inverse Only
(01h)**



**Inverse Autodetect
(02h)**

Redundancy Level

Parameter # 4Eh

The digital scanner offers four levels of decode redundancy. Select higher redundancy levels for decreasing levels of bar code quality. As redundancy levels increase, the digital scanner's aggressiveness decreases.

Select the redundancy level appropriate for the bar code quality.

Redundancy Level 1

The following code types must be successfully read twice before being decoded:

Table 11 Redundancy Level 1 Codes

Code Type	Code Length
Codabar	8 characters or less
MSI	4 characters or less
D 2 of 5	8 characters or less
I 2 of 5	8 characters or less

Redundancy Level 2

The following code types must be successfully read twice before being decoded:

Table 12 Redundancy Level 2 Codes

Code Type	Code Length
All	All

Redundancy Level 3

Code types other than the following must be successfully read twice before being decoded. The following codes must be read three times:

Table 13 Redundancy Level 3 Codes

Code Type	Code Length
MSI	4 characters or less
D 2 of 5	8 characters or less
I 2 of 5	8 characters or less
Codabar	8 characters or less

Redundancy Level 4

The following code types must be successfully read three times before being decoded:

Table 14 Redundancy Level 4 Codes

Code Type	Code Length
All	All

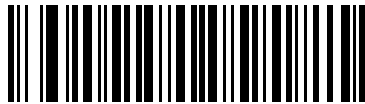

*Redundancy Level 1
(01h)

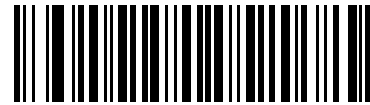

Redundancy Level 2
(02h)

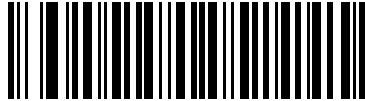

Redundancy Level 3
(03h)



Redundancy Level 4
(04h)

Security Level

Parameter # 4Dh

The digital scanner offers four levels of decode security for delta bar codes, which include the Code 128 family, UPC/EAN, and Code 93. Select increasing levels of security for decreasing levels of bar code quality. There is an inverse relationship between security and digital scanner aggressiveness, so choose only that level of security necessary for any given application.

- **Security Level 0:** This setting allows the digital scanner to operate in its most aggressive state, while providing sufficient security in decoding most “in-spec” bar codes.
- **Security Level 1:** This default setting eliminates most misdecodes.

- **Security Level 2:** Select this option if Security level 1 fails to eliminate misdecodes.
- **Security Level 3:** If you selected Security Level 2 and misdecodes still occur, select this security level. Be advised, selecting this option is an extreme measure against mis-decoding severely out of spec bar codes. Selecting this level of security significantly impairs the decoding ability of the digital scanner. If you need this level of security, try to improve the quality of the bar codes.

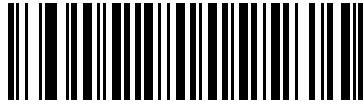

***Security Level 0**
(00h)

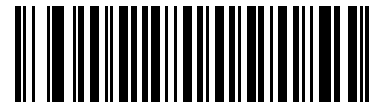

Security Level 1
(01h)

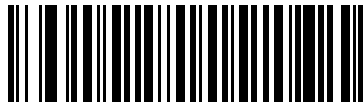

Security Level 2
(02h)

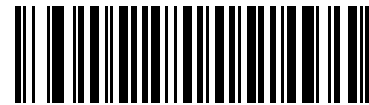

Security Level 3
(03h)

Intercharacter Gap Size

Parameter # F0h, 7Dh

The Code 39 and Codabar symbologies have an intercharacter gap that is typically quite small. Due to various bar code-printing technologies, this gap can grow larger than the maximum size allowed, preventing the digital scanner

from decoding the symbol. If this problem occurs, scan the **Large Intercharacter Gaps** parameter to tolerate these out-of-specification bar codes.



***Normal Intercharacter Gaps
(06h)**



**Large Intercharacter Gaps
(0Ah)**

Report Version

Scan the bar code below to report the version of software installed in the digital scanner.

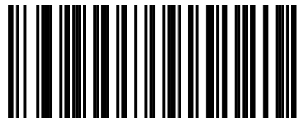

Report Software Version

Macro PDF Features

Macro PDF is a special feature for concatenating multiple PDF symbols into one file. The scanner can decode symbols that are encoded with this feature, and can store more than 64 Kb of decoded data stored in up to 50 MacroPDF symbols.



CAUTION:When printing, keep each Macro PDF sequence separate, as each sequence has unique identifiers. Do not mix bar codes from several Macro PDF sequences, even if they encode the same data. When scanning Macro PDF sequences, scan the entire Macro PDF sequence without interruption. If, when scanning a mixed sequence, the digital scanner emits two long low beeps (Low/Low) this indicates an inconsistent file ID or inconsistent symbology error.

Flush Macro Buffer

This flushes the buffer of all decoded Macro PDF data stored to that point, transmits it to the host device, and aborts from Macro PDF mode.



Flush Macro PDF Buffer

Abort Macro PDF Entry

This clears all currently-stored Macro PDF data in the buffer without transmission and aborts from Macro PDF mode.



Abort Macro PDF Entry

Bluetooth Connection Using HID and SPP Profiles

Introduction

The RS507 is designed to connect over Bluetooth and also operate hand in hand with a personal computer or non-Zebra terminals. This chapter describes the Bluetooth connection modes of the RS507 to a personal computer and non-Zebra terminals.

This chapter includes the following sections:

- [RS507 to Computer Bluetooth Connection Modes on page 162](#)
- [RS507 Important hardware features on page 163](#)
- [Refreshing Boot Choices on page 163](#)
- [HID \(Human Interface Device\) Mode on page 164](#)
- [Serial Port Profile \(SPP\) Mode on page 178](#)
- [Firmware upgrade on page 198](#)
- [Retrieving the RS507 log file on page 202](#)
- [Bluetooth Bar Codes on page 206](#)

RS507 to Computer Bluetooth Connection Modes

The RS507 can connect to a computer over Bluetooth using the Serial Port Profile (SPP) or Human Interface Device (HID) Bluetooth modes.

SSI (SCAN) Mode

SSI Simple Serial Interface (SCAN) is the default mode before changing to operate in SPP or HID Bluetooth mode.

SSI (SCAN) mode is also used when the RS507 is connected to a Zebra MPA-based mobile terminal or when using the PC Tool application ([Upgrading using a computer and the PC Tool application on page 198](#)).

Serial Port Profile (SPP) Mode

The SPP mode is used when the RS507 is connected to a computer as serial device.

The data of the scanned bar codes is transferred directly to the serial port of the computer. The scanned data can be edited by a wedge application.

Human Interface Device (HID) Mode

In HID mode, the RS507 is connected over Bluetooth to a computer as a keyboard device. The computer decodes the emulated key strokes sent by the RS507. The scanned data can be received by any Windows application that accepts keyboard data.

The scanned data can also be processed to suit particular requirements before transmitted to a computer application using Advanced Data Formatting (ADF). For information and programming bar codes for ADF, refer to the Advanced Data Formatting Programmer Guide, p/n 72E-69680-xx (refer only to the programming bar codes that relate to bar code imagers, not Laser bar code scanners).

RS507 Important hardware features

The following figure shows important hardware features of the RS507 referred to in this section.

Figure 55 RS507 Important hardware features

Trigger Configuration

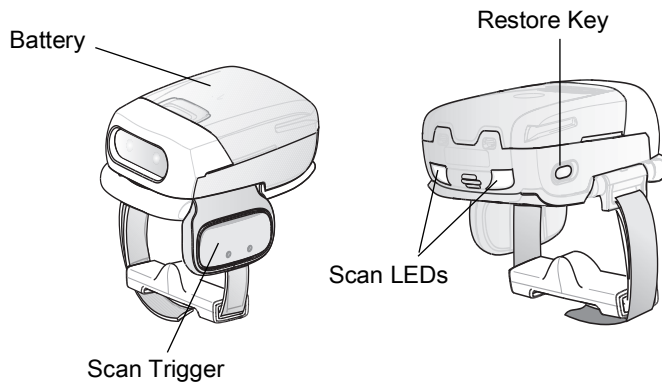

Triggerless Configuration

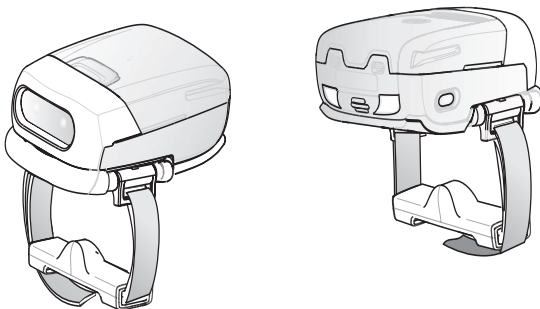

Refreshing Boot Choices

The following boot choices are referred to in this section:

Cold Boot

Cold Boot restores the RS507 operation by resetting its software. To perform a cold boot, remove and re-insert the battery onto the RS507.

Clean Boot

Clean Boot restores the RS507 to its factory default configuration.

To perform Clean Boot:

1. Remove the battery from the RS507.
2. Press and hold the Restore Key.
3. Insert the Battery onto the RS507.
4. Keep holding the Restore Key pressed for about five seconds until a chirp is heard and the Scan LEDs flash green. The RS507 is now in its factory default configuration.

Warm Boot

Warm boot restores the RS507 operation by resetting its software but retains the RAM content. Warm boot is used when a log file has to be retrieved from the RS507 during application debugging.

To perform warm boot, press and hold the Restore Key for more than six seconds.

HID (Human Interface Device) Mode

- ✓ **NOTE:** Notebook computer manufacturers may provide their own brand of a Bluetooth stack with different connection screens. However, all stacks provide the same functionality.

How to change to HID mode

1. Perform Clean Boot to the RS507:
 - Remove the battery from the RS507.
 - Press and hold the Restore key.
 - Install the battery onto the RS507.
 - Keep holding the **Restore key** pressed for about five seconds until a chirp is heard and the **Scan LEDs** flash green.
2. Scan the HID bar code.

HID bar code



3. Perform a Cold Boot by removing and re-installing the battery onto the RS507. The RS507 starts to operate and is discoverable as a keyboard.

How to format the scanned data

Advanced Data Formatting (ADF)

The scanned bar code data can be processed and formatted before the RS507 sends it to an application. For Zebra Advanced Data Formatting. For information and programming bar codes for ADF, refer to the Advanced Data Formatting Programmer Guide, p/n 72E-69680-xx (refer only to the programming bar codes that relate to bar code imagers, not Laser bar code scanners).

How to pair and connect with a computer running Windows 7 SP1

- ✓ **NOTE:** - For best user experience, it is recommend using Secure Simple Pairing (SSP). Windows 7 SP1 supports Bluetooth 2.1 and as such, supports SSP.
- SSP reduces the number of steps to minimal or none when compared to legacy Bluetooth pairing.
 - If the computer does not include an integrated Bluetooth module, a USB Bluetooth dongle can be used.
 - Use off-the-shelf dongle that supports Bluetooth v2.1 for effortless pairing in SSP.

To pair and connect the RS507:

1. Right click on Bluetooth icon and select **Open Setting > Add a Device**.

Figure 56 HID - Open Setting Screen - Windows 7 SP1

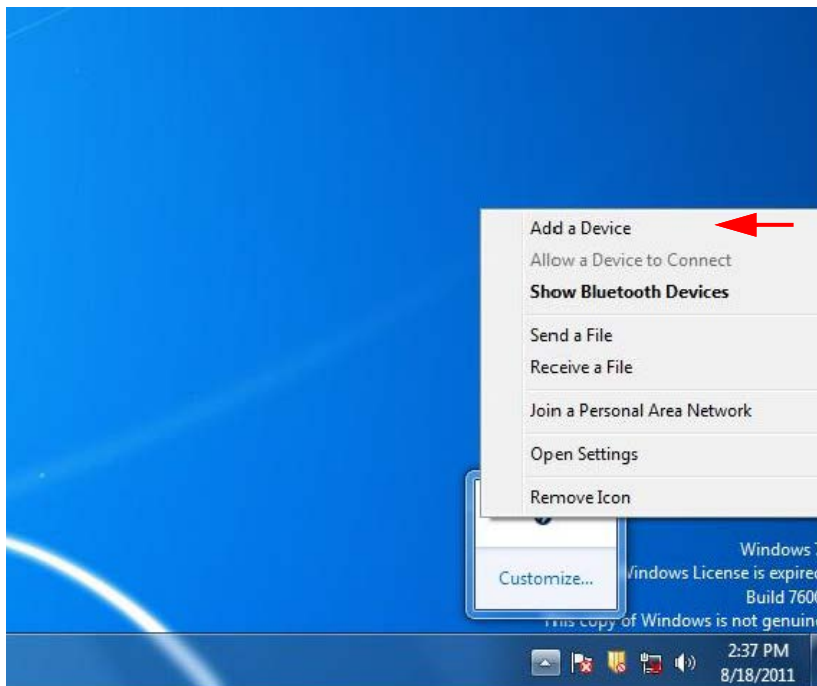

2. From the **Add a device** screen, select the RS507 (shown as Bluetooth Keyboard) and click **Next**.

Figure 57 HID - Add Device Screen - Windows 7 SP1

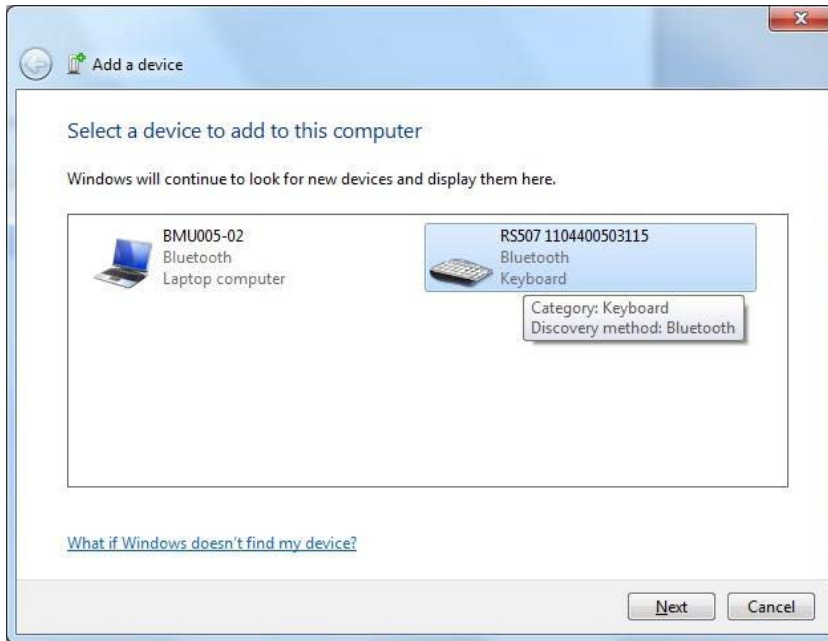

The computer connects to the RS507 and the following screen is displayed.

Figure 58 HID - Device Successfully Added Screen - Windows 7SP1

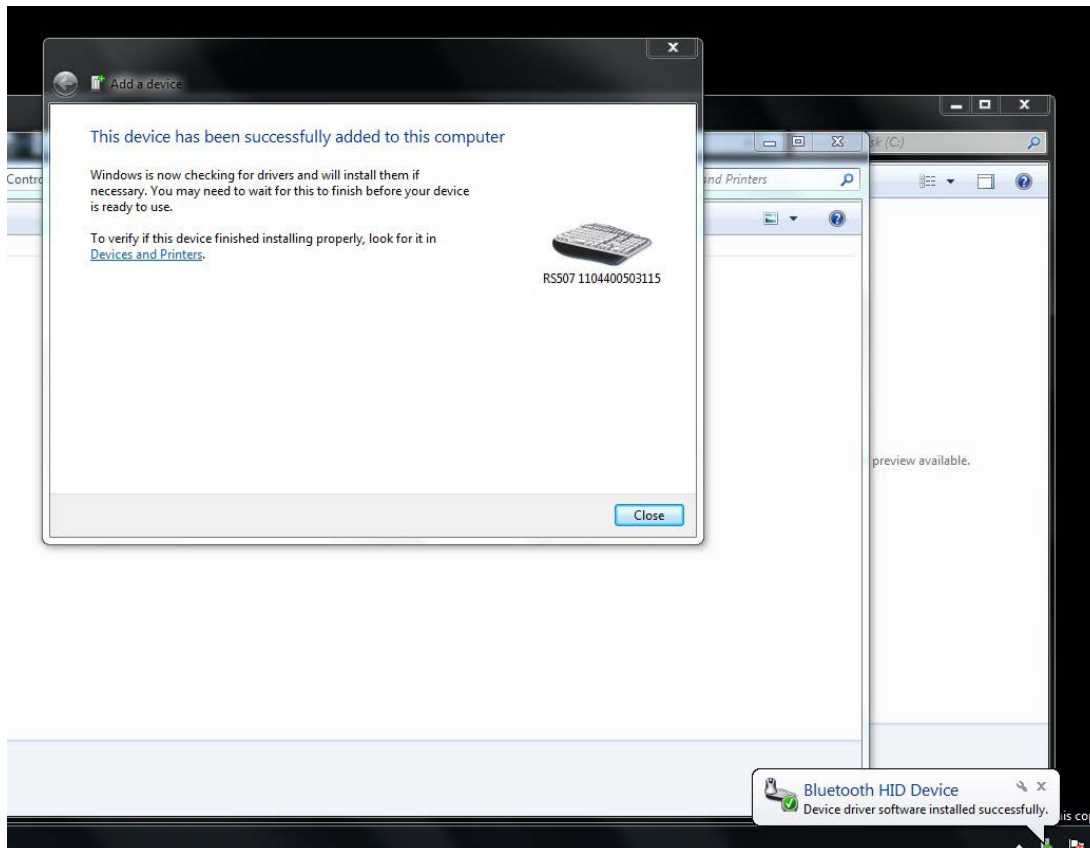

How to pair and connect with a computer running Windows XP SP3 and Bluetooth 2.1

For best user experience it is recommended to use Secure Simple Pairing (SSP) that is supported in Bluetooth V2.1. SSP reduces the number of steps to minimal or none when compared to legacy Bluetooth pairing.

To pair and connect with a computer:

1. Verifying that Windows XP Service Pack 3 (SP3) is installed.
2. Since Windows XP does not support Bluetooth V2.1, load new Bluetooth stack that supports Bluetooth V2.1 by either:
3. Following the instructions on the Broadcom site at: www.broadcom.com/support/bluetooth/update.php and install the WIDCOMM stack.
4. Purchasing an off-the-shelf USB Bluetooth dongle that supports Bluetooth V2.1 and installing the provided Bluetooth V2.1 drivers. Using USB Bluetooth dongle is the only option if the computer does not include an integrated Bluetooth module. When using earlier Bluetooth versions, you will need to enter passkey **12345** or disable authentication by scanning:

Disable Authentication bar code



Pair and connect the RS507 as follows:

1. Right click the Bluetooth icon on the computer desktop tray.

Figure 59 HID - Bluetooth Icon On Computer Desktop Tray - Windows XP SP3 and Bluetooth V2.1



Or

From My Bluetooth Places > Bluetooth Tasks bar, select Add a Bluetooth Device.

Figure 60 HID - My Bluetooth Places Screen - Windows XP SP3 and Bluetooth V2.1

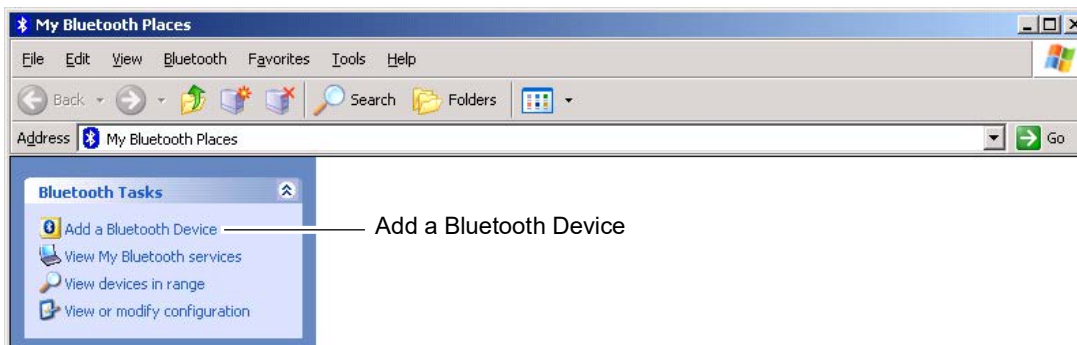

2. Check the My device set up and ready to be found box and click **Next**.

Figure 61 HID - Bluetooth Setup Screen - Windows XP SP3 and Bluetooth V2.1

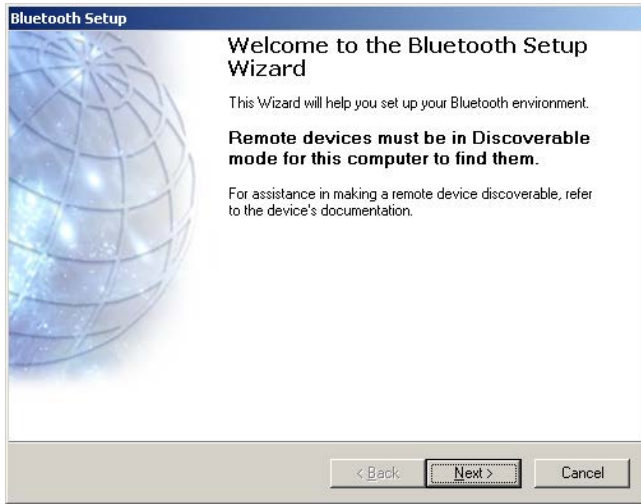

3. Verify that the RS507 is found by the Host in the **Bluetooth Device Selection** screen. Select the RS507 and click **Next** to start the SSP process.

Figure 62 HID - Bluetooth Device Selection Screen - Windows XP SP3 and Bluetooth V2.1



The Secure Simple Pairing starts.

Figure 63 HID - Bluetooth Security Setup Screen - Windows XP SP3 and Bluetooth V2.1

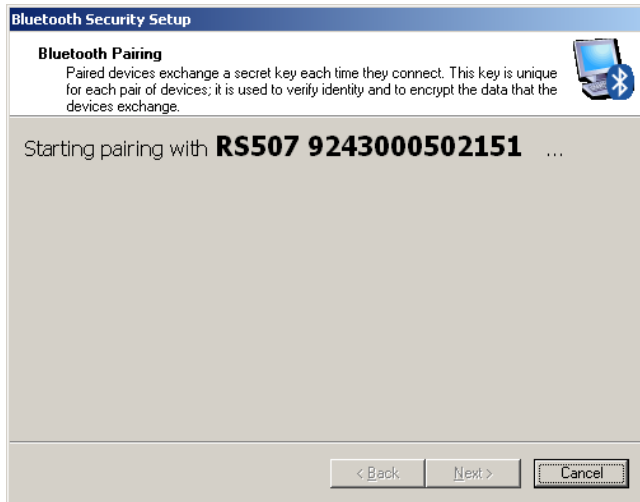

If earlier Bluetooth stack is used (not equipped with SSP), check the **Let me choose my own passkey** button, enter **12345** (or scan the Disable Bluetooth Authentication bar code) and click **Next**. The pairing process completes and the RS507 connects without any further intervention.

Figure 64 HID - Bluetooth Pairing Success Screen - Windows XP SP3 and Bluetooth V2.1

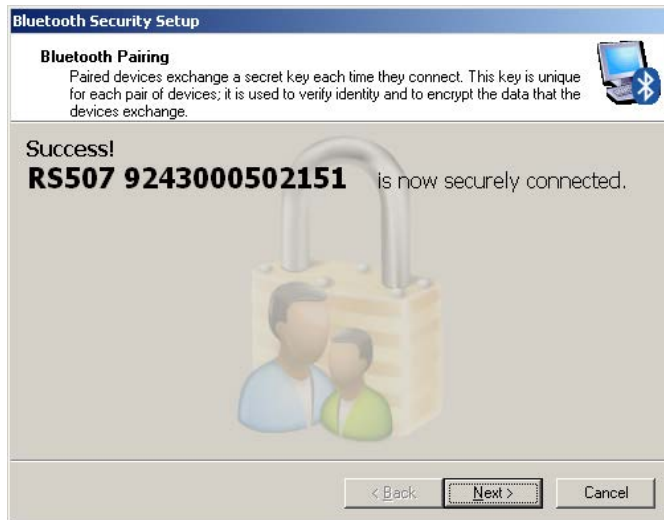

Upon successful Bluetooth pairing, the Bluetooth icon in the computer desktop tray turns green.

Figure 65 HID - Bluetooth Icon In Computer Desktop Tray - Windows 7SP1



✓ **NOTE:** The next time you explore the **Bluetooth Devices Selection** screen, the RS507 will show connected.

Figure 66 HID - Select a device Screen - Windows XP SP3 and Bluetooth V2.1

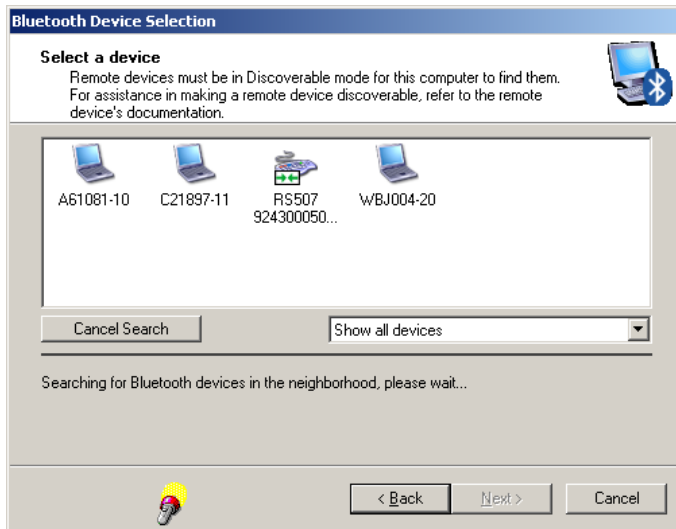

1. If pairing results in an error, remove the RS507 from the Bluetooth stack by selecting it on the **My Bluetooth Places \ Entire Bluetooth Neighborhood** screen, right click and select **Disable**.

Figure 67 HID - Entire Bluetooth Neighborhood Screen - Windows XP SP3 and Bluetooth V2.1

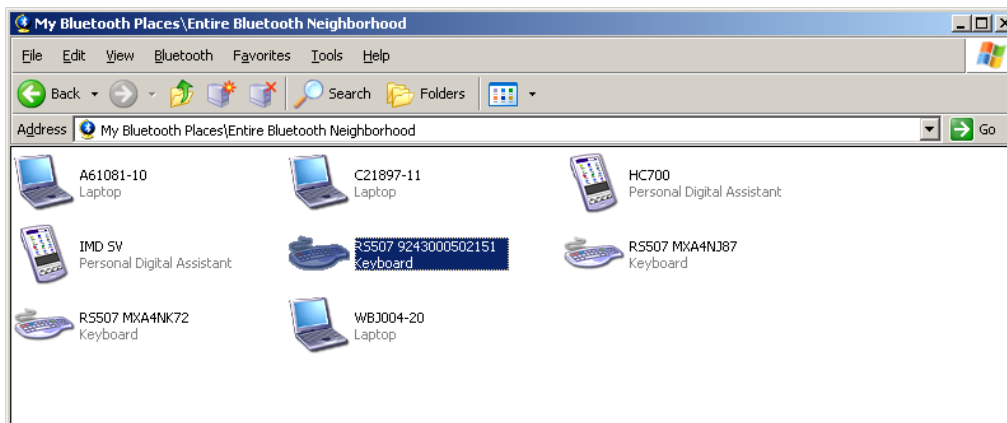

2. Scan the Un-Pairing bar code.

Un-pairing bar code



3. The RS507 emits one string of high/low beeps indicating that Bluetooth communication with the PC is removed.
4. If that does not help, perform Clean Boot (see [Clean Boot on page 164](#)) the RS507 and start the Bluetooth pairing again.

How to pair and connect with other devices

The RS507 can pair and connect as an emulated keyboard using the Bluetooth HID profile to other devices that support HID using the device discovery feature.

- ✓ **NOTE:** Not all devices support HID. If the RS507 is not discovered as a keyboard (when it is in HID mode), consult the device information.

Reconnecting

Automatic reconnection

The RS507 maintains Bluetooth communication with the connected device within a range of 10 meters (30 feet).

When the RS507 fails to establish connection or connection is lost during operation:

1. The RS507 emits one string of low/high beeps.
2. The RS507 automatically attempts to reconnect to the computer for 30 seconds (the Scan LEDs flash green).

Manual reconnection to Restore Lost Bluetooth Connection

If automatic re-connection fails, verify that the RS507 is within Bluetooth range and briefly press the small Restore key on the side of the RS507 to reconnect.

1. The RS507 Scan LEDs start to flash green, indicating that the RS507 is attempting to establish connection with the computer.
2. The Scan LEDs turn off and the RS507 emits one string of low/high beeps indicating that the RS507 is connected and ready for scanning.

- ✓ **NOTE:** When the RS507 is in HID connection mode, pressing the **Restore key** after any RS507 boot reconnects the RS507 to the last paired device. Connection is established as long as the link key (the authentication key used to establish a link between devices) on the RS507 side is not deleted.

How to demonstrate HID connection with a computer

Following a successful connection, data can be scanned into any Windows application field that accepts keyboard data; for example, the Notepad application.

To scan a bar code:

1. Run the Notepad application.
2. Scan a bar code. The scanned bar code information is displayed on the Notepad window.

Figure 68 HID - Scanned Bar Code Information On Notepad Window

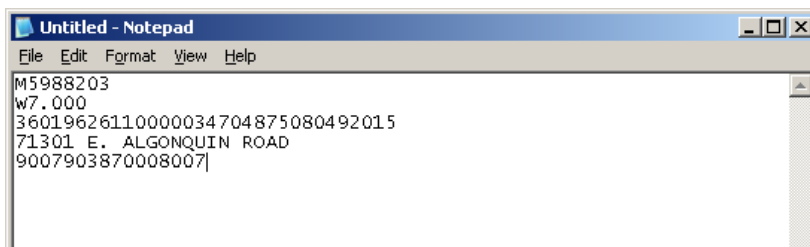

Country keyboard type change

While in HID mode, the RS507 supports several keyboard layouts.

To change the North American Standard Keyboards layout (see bar code marked by * below) to a different country code layout, scan the required bar code corresponding to the country keyboard type.



*North American Standard Keyboards



French Windows



German Windows



French Canadian Windows 98



Spanish Windows



Italian Windows



Swedish Windows



UK English Windows



Japanese Windows



French Canadian Windows 2000/XP



Portuguese/Brazilian Windows

Connecting multiple RS507 into single device

Multiple RS507 devices can concurrently connect to one device application.

In HID connection mode, all RS507 devices enter their virtual key strokes into the same data field of the device application.

Using random PIN code

To establish a Bluetooth connection with a computer using a random PIN code:

1. Scan the bar code of the Variable PIN code.



2. On the **Windows Explorer** screen, click the **My Bluetooth Places** icon.
3. From the **Bluetooth Tasks** bar, click on **Add a Bluetooth Device** to start the **Bluetooth Setup** wizard.

Figure 69 HID - Using Random PIN Code - My Bluetooth Places Screen

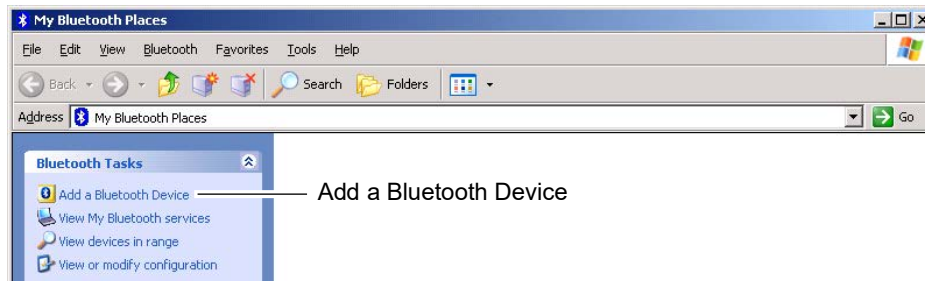

4. On **Bluetooth Setup** screen, click the **Next** button.

Figure 70 Using Random PIN Code - Bluetooth Setup Wizard Screen

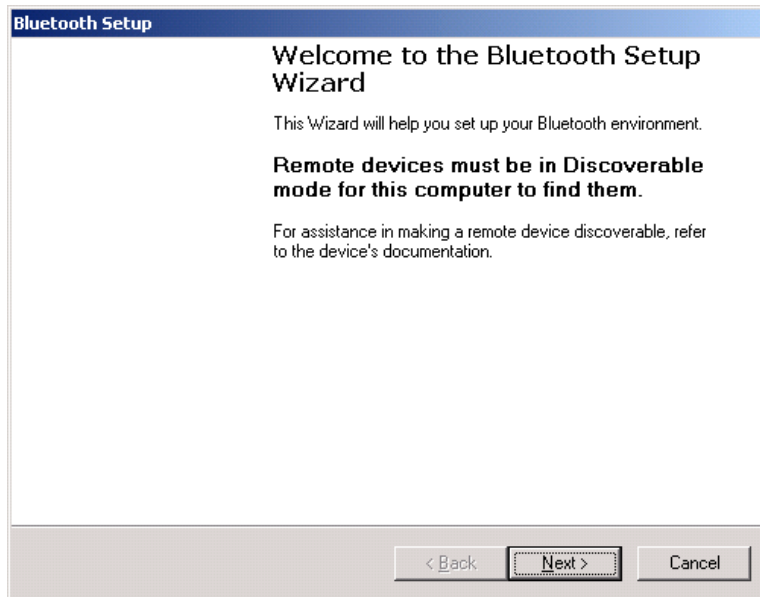

5. On the **Bluetooth Device Selection** screen, select the RS507 displayed as a keyboard icon (MXA4NH80 is the serial number of the RS507) and click the **Next** button.

Figure 71 HID - Using Random PIN Code - Bluetooth Device Selection Screen

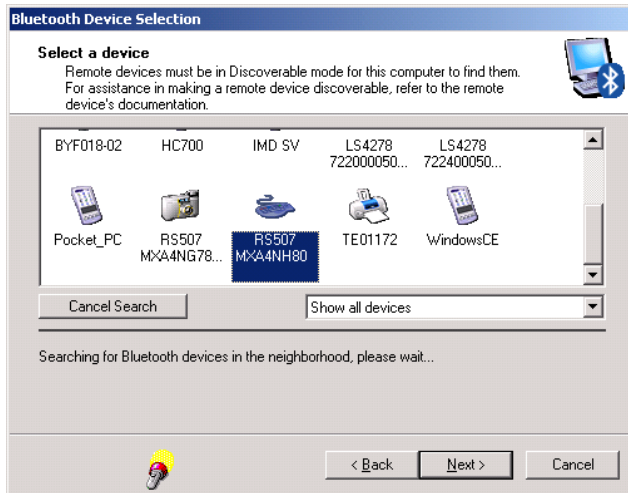

The RS507 beeps once indicating that it is waiting for an alphanumeric passkey entry.

Figure 72 HID - Using Random PIN Code - Bluetooth Security / Alphanumeric Passkey Entry Screen

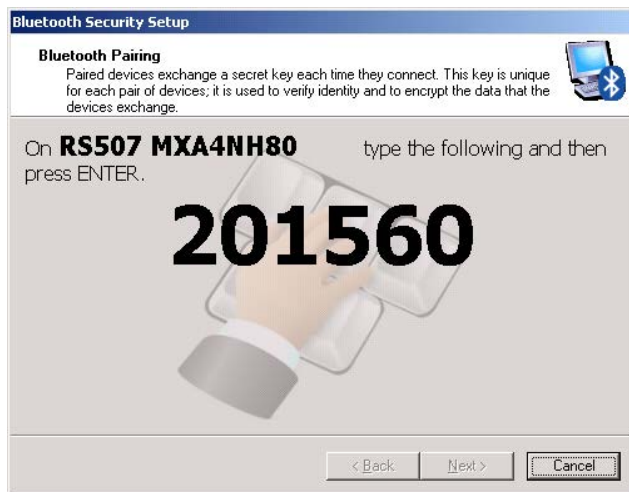

6. Enter the provided passkey by scanning the alphanumeric bar codes shown below.

Alphanumeric Keyboard Bar Codes

0



1



2



3



4



5



6



7



8



9



CANCEL



- Scan the End of Message bar code if the PIN code has less than 16 characters.

End of Message bar code



The RS507 emits a short high beep while scanning the alphanumeric bar codes and a high/low/high/low upon scanning the End of Message bar code. When the passkey is scanned successfully, Success! is displayed on the **Bluetooth Security Setup** screen.

Figure 73 HID - Using Random PIN Code - Bluetooth Security Screen / Passkey Scanned Successfully

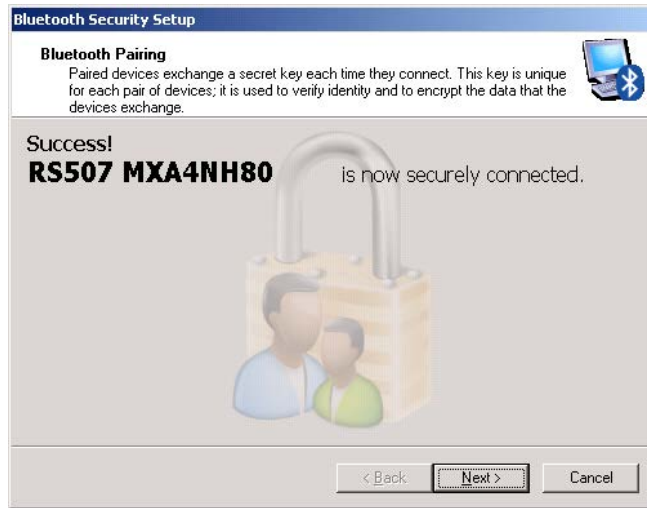

- Click **Next** to complete the association. The RS507 emits a short string of low/high beeps to indicate a successful pairing. When the connection is completed, the color of the Bluetooth icon on the quick launch bar of the PC is blue and green.

Figure 74 HID - Using Random PIN Code - Successful Pairing Bluetooth Icon

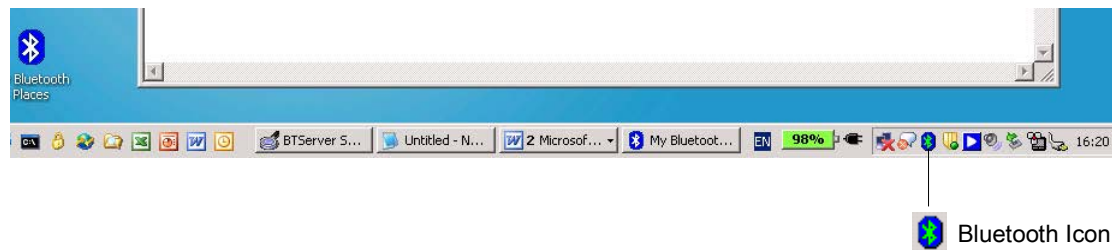

How to return to SSI (SCAN) mode

To return to SSI mode so that connection to Zebra terminals can be established, perform the following:

- Perform Clean Boot to the RS507:
 - Remove the battery from the RS507.
 - Press and hold the Restore key.
 - Install the Battery onto the RS507.
 - Keep holding the Restore key pressed for about five seconds until a chirp is heard and the **Scan LEDs** flash green.

2. Scan the SSI (SCAN) bar code..

✓ **NOTE:** The SCAN (SCAN) bar code can also be scanned directly from a computer screen.

SSI (SCAN) bar code



3. Perform a Cold Boot by removing and re-installing the battery onto the RS507 (see [Cold Boot on page 164](#)). The RS507 starts to operate using SSI (SCAN) mode.

Serial Port Profile (SPP) Mode

The RS507 can connect to a computer or other device that supports Bluetooth SPP interface as either a Central (the RS507 initiate the connection) or a Peripheral (the computer or other device initiate the connection and the RS507 is discovered by the computer).

✓ **NOTE:** Notebook computer manufacturers may provide their own brand of a Bluetooth stack with different connection screens. However, all stacks provide the same functionality.

How to change to SPP mode

✓ **NOTE:** - Since the SPP connection does not support automatic acknowledgement when the data is received by the computer application, a BELL indication is used. The BELL indication allows the computer application to send single binary character 0x07 to the RS507 (as defined in ASCII table). Upon receiving the BELL character, the RS507 beeps. To configure the beep, see [BELL Indication \(SPP mode only\) on page 209](#).

To change the RS507 to SPP mode:

1. Perform Clean Boot to the RS507 (see [Clean Boot on page 164](#)):
 - Remove the battery from the RS507.
 - Press and hold the Restore key.
 - Install the Battery onto the RS507.
 - Keep holding the Restore key pressed for about five seconds until a chirp is heard and the **Scan LEDs** flash green.
2. Scan SPP bar code.

SPP bar code



3. Perform a Cold Boot by removing and re-installing the battery onto the RS507. The RS507 starts to operate and is discoverable as a Bluetooth serial device (like a camera).

How to format the scanned data the data

Advanced Data Formatting (ADF)

The scanned bar code data can be processed and formatted before the RS507 sends it to an application using Advanced Data Formatting (ADF).

For information and programming bar codes for ADF, refer to the Advanced Data Formatting Programmer Guide, p/n 72E-69680-xx (refer only to the programming bar codes that relate to bar code imagers, not Laser bar code scanners).

Wedge

The scanned bar code data can also be processed and formatted before the RS507 send it to the application by using a 3rd party data wedge application. Such wedge applications are available for free download from 3rd party providers sites.

How to pair and connect with a computer running Windows 7 SP1

SPP connection with RS507 as a Central

1. Right click on the Bluetooth icon and select **Open Setting** to add a COM port

Figure 75 SPP - Open Setting Screen - Windows 7 SP1

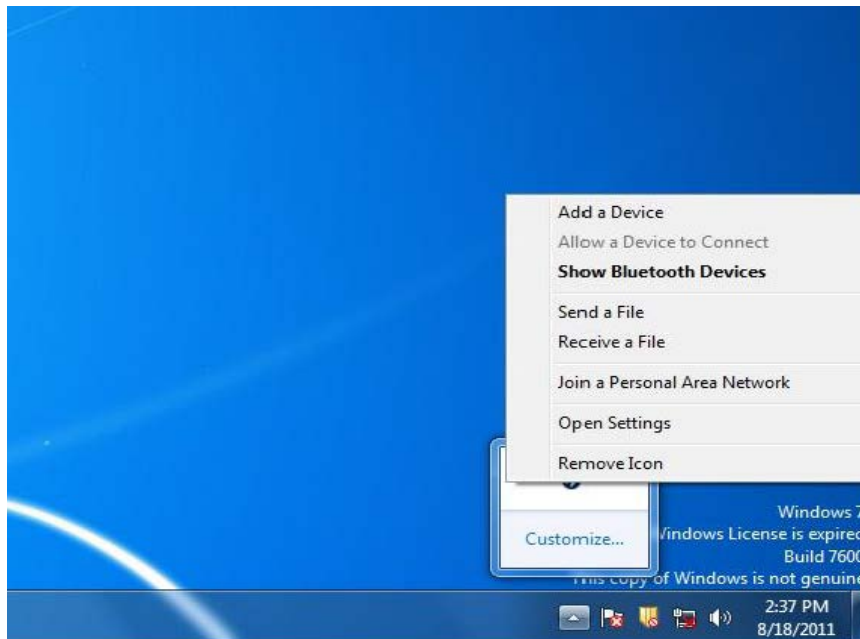

2. Select the **COM Ports** tab and click **Add**.

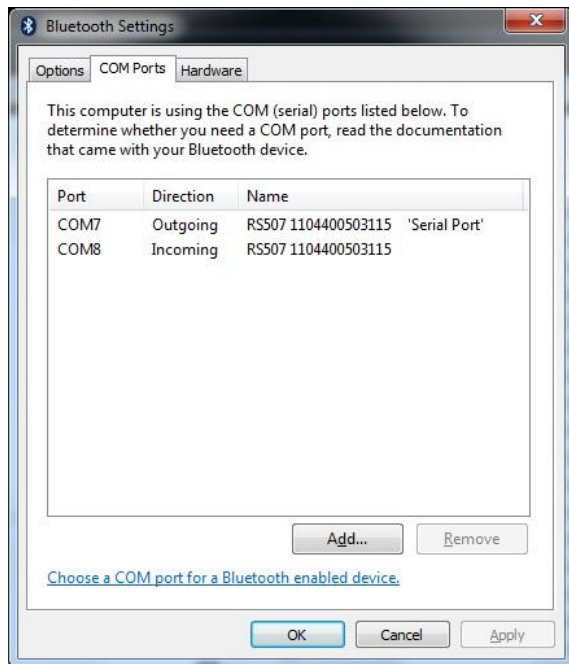
Figure 76 SPP - Bluetooth Settings - Com Ports Tab

3. Check the **Incoming** box and click **OK**.

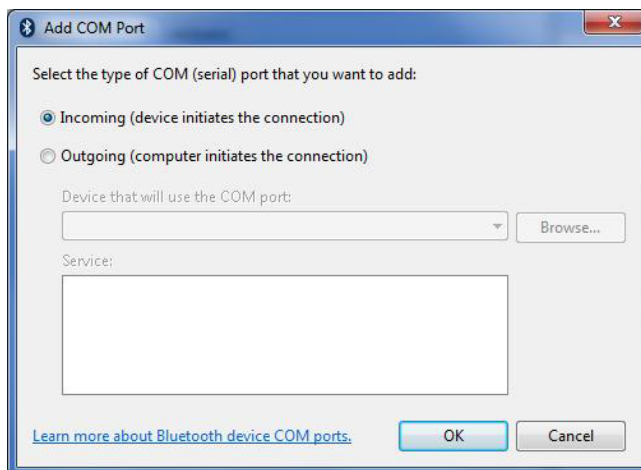
Figure 77 SPP - Bluetooth Settings - Add Com Port Screen

4. Click the **Hardware** tab to retrieve the Bluetooth radio BD address.

Figure 78 SPP - Bluetooth Settings - Bluetooth Radio BD Address

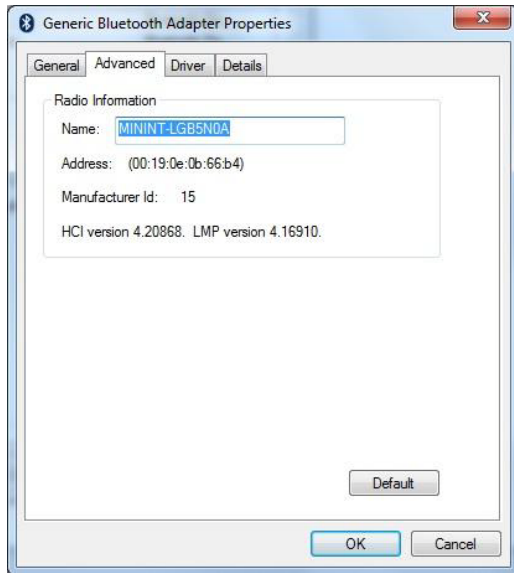

5. Run the PC Tool application.

Figure 79 SPP - PC Tool application

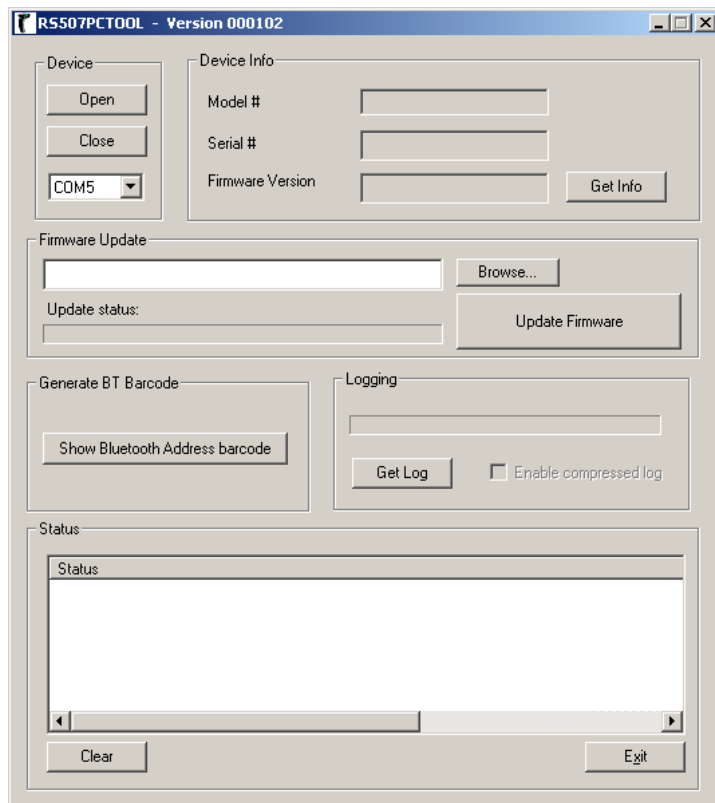

6. Click the **Show Bluetooth Address barcode** button.
7. Manually enter the BD address to the PC Tool application and click the **Generate** button.

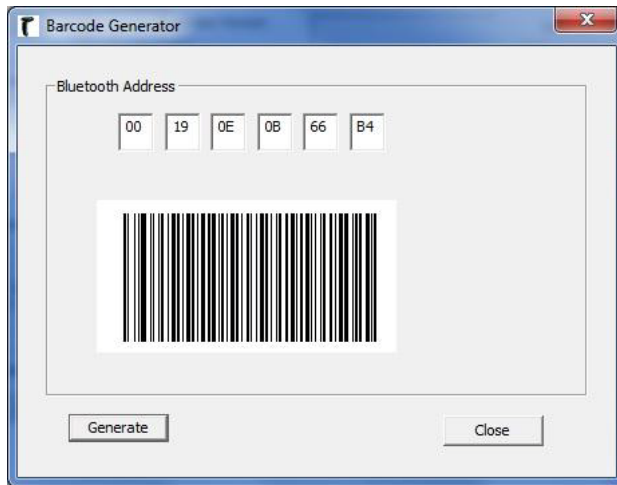
Figure 80 SPP - PC Tool Application - Bar Code Generator

8. Open the incoming COM port assigned (for example, COM7) in the application. After the COM port is opened the computer connects to the RS507 and a beep will sound. For demonstration, refer to *How to demonstrate SPP connection with a computer on page 11-193*.

✓ **NOTE:** If the COM port is not opened prior to the connection, the RS507 will fail to connect.

9. To start the connection process:
 - Aim the RS507 at about 7" (18 cm) away from the computer screen and scan the bar code of the BD address of the computer (or the other target device).
 - The RS507 Scan LEDs start flashing green indicating that the RS507 is attempting to establish connection with the computer. The following notifications are displayed upon successful connection.

Figure 81 SPP - Device Successfully Added Screen

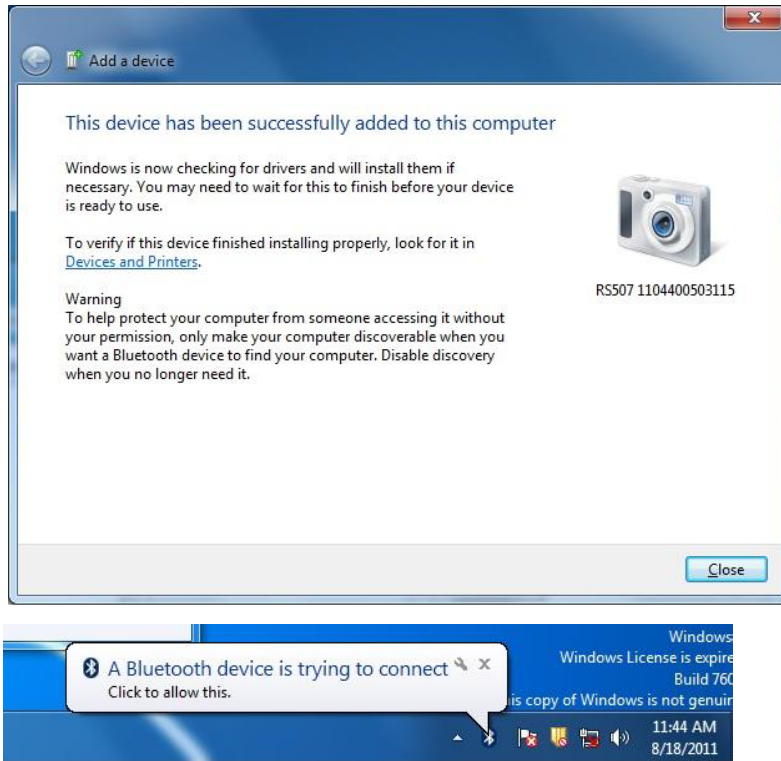

✓ **NOTE:** In case you do not hear the connected beep on the RS507, press on the RS507 **Restore key** to connect.

SPP connection with RS507 as a Peripheral

1. Right click the Bluetooth icon and select **Open Settings > Add Device**.

Figure 82 SPP connection with RS507 as a Peripheral - Open Settings

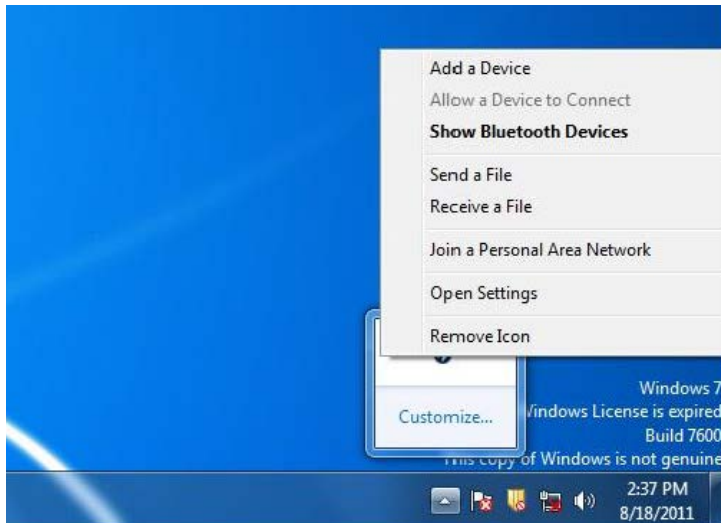

2. Select the RS507 (see Bluetooth Camera icon below) and click **Next**

Figure 83 SPP connection with RS507 as a Peripheral - Add Device Screen



3. The computer attempts to connect to the RS507.

Figure 84 SPP connection with RS507 as a Peripheral - Device Successfully Added Screen

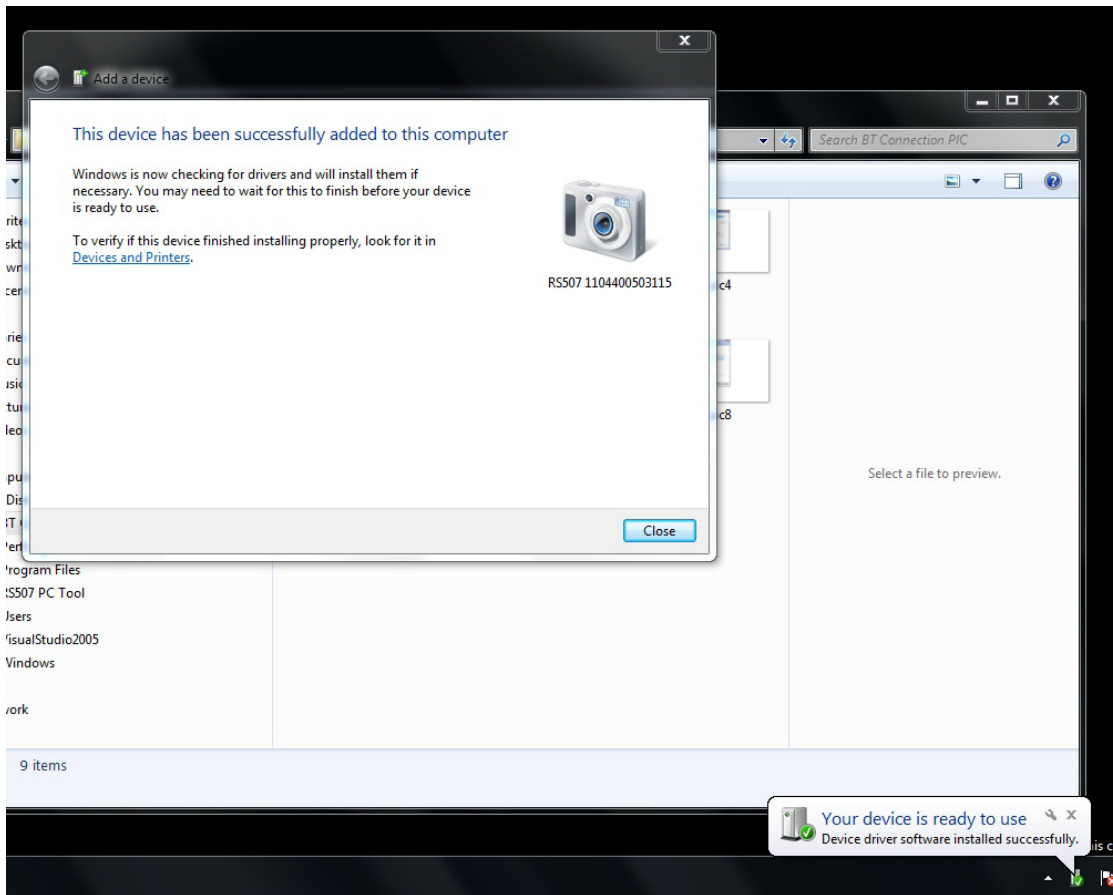

4. Open the incoming COM port assigned (for example, COM7) in the application. After the COM port is opened the computer connects to the RS507 and a beep will sound. For demonstration, refer to <Blue><Italic>How to demonstrate SPP connection with a computer on page 11-193.

✓ **NOTE:** Make sure the same COM port is closed in other applications.

How to pair and connect with a computer running Windows XP SP3

SPP connection with RS507 as a Central

To pair the RS507 with a computer:

1. Find the Bluetooth Device (BD) address of the computer (or the target device) in **Bluetooth Configuration > Diagnostics** tab.

Figure 85 Bluetooth Configuration Screen - Windows XP SP3

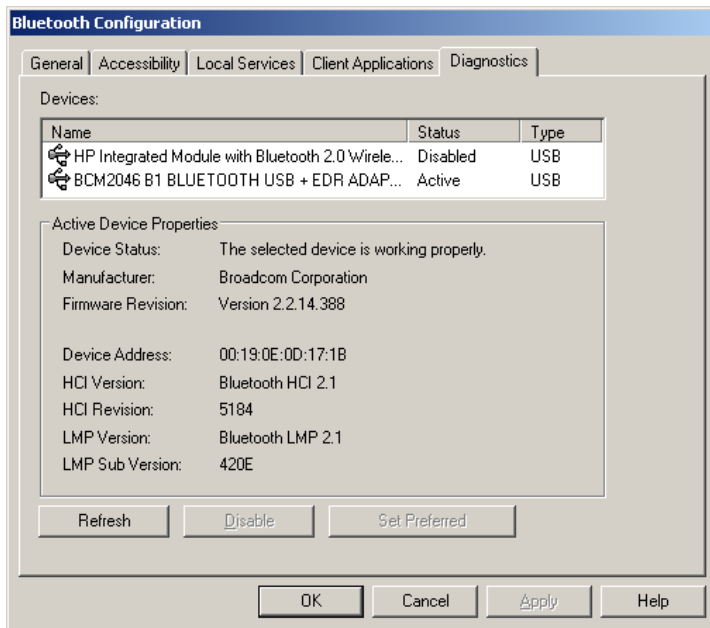

2. Run the PC Tool application.

Figure 86 PC Tool Application Screen

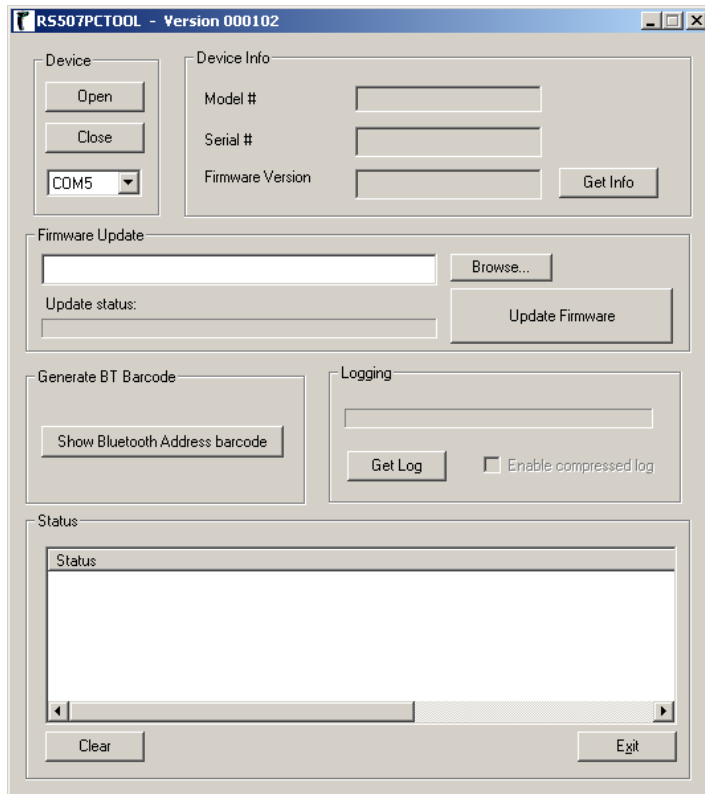

3. Click the **Show Bluetooth Address barcode** button.
4. Manually enter the computer BD address and click the **Generate** button.

Figure 87 PC Tool Application - Bar Code Generator

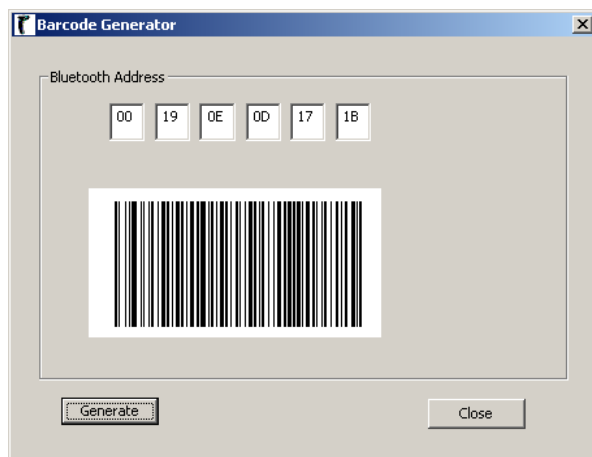

✓ **NOTE:** The PC Tool application retains the last BD address entered. To recreate a new bar code image, enter the BD address and click the Generate button.

5. To start the connection process, aim the RS507 at about 7" (18 cm) away from the front of the computer screen.
6. Scan the bar code of the BD address of the computer (or other target device).

7. The RS507 Scan LEDs start flashing green indicating that the RS507 is attempting to establish connection with the computer.
8. Check the **Always allow this device to access this service** box and click **OK**.

Figure 88 Bluetooth Service Authorization Dialog



- ✓ **NOTE:** When using an earlier Bluetooth version that is not equipped with Secure Simple Pairing, a passkey is required only for the first connection. Check the **Let me choose my own passkey** button, enter **12345** and click **Next**.

Upon successful Bluetooth pairing, RS507 bleeps and the Bluetooth icon in the computer desktop tray turns green.

Figure 89 Bluetooth Icon In Computer Desktop Tray - Windows XP SP3



At this point, the RS507 is ready to scan and send bar codes over the assigned serial port.

9. Find the assigned serial incoming port, right click the Bluetooth icon and select **Bluetooth Configuration > Client Applications** tab.

- ✓ **NOTE:** Do not confuse the Bluetooth serial port assigned as Incoming (RS507 initiates the connection) with the Bluetooth serial port assigned as Outgoing (The computer initiates the connection and RS507 is discovered - Peripheral Mode).

Figure 90 Bluetooth Configuration Screen - Windows XP SP3

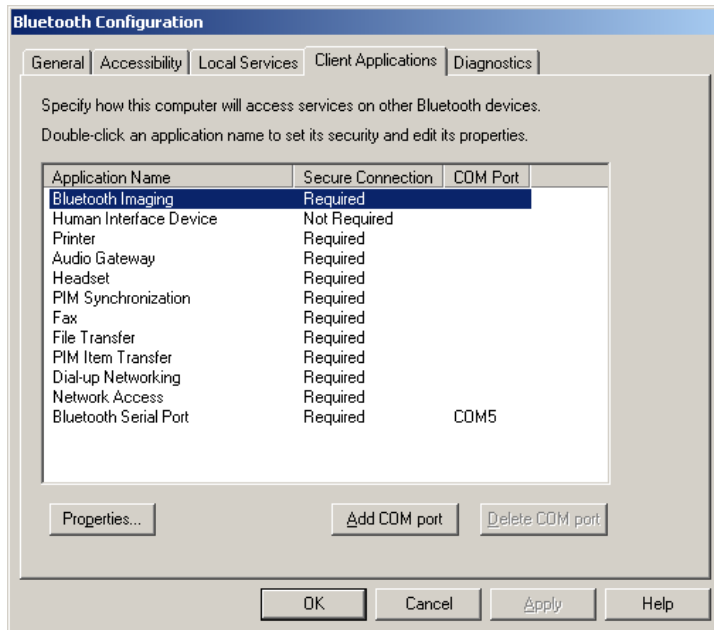

The COM ports can also be identified through the Control Panel.

To access the Bluetooth COM port allocation through the Control Panel:

1. From the **Control Panel** screen, open the **Bluetooth Devices** screen on the computer.

Figure 91 Bluetooth Devices screen - Windows XP SP3

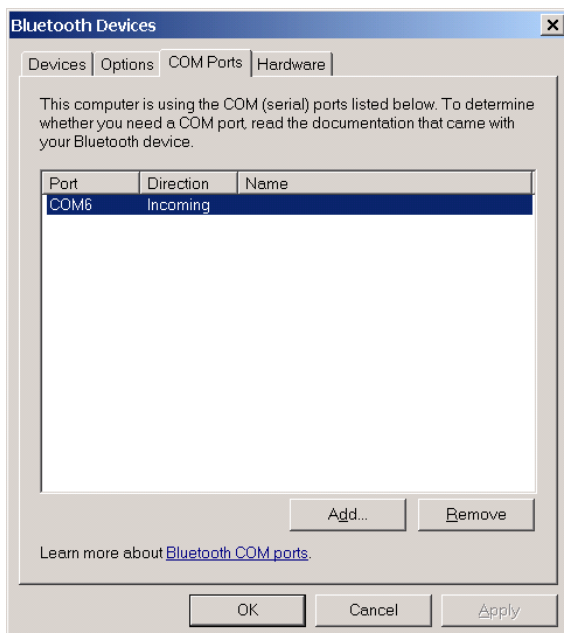

2. Click the **COM Ports** tab and verify that a COM port is assigned. If no COM port is assigned, click the **Add** button and select **Incoming (device initiates the connection)** to set the RS507 as Central and the computer as Peripheral.
3. Click **OK** to complete the settings.

Figure 92 Add COM Port Screen - Windows XP SP3

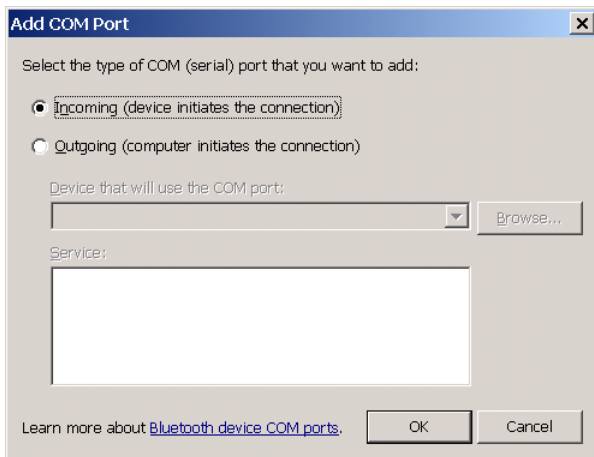

4. After the Bluetooth COM port is assigned, run the application on the computer and open the COM port assigned as Incoming in the application (for example, COM7). After the COM port is opened, the computer connects to the RS507 and a beep will sound. For demonstration, refer to *How to demonstrate SPP connection with a computer on page 11-193*.

✓ **NOTE:** If the COM port is not opened prior to the connection, the RS507 will fail to connect. Make sure the same COM port is closed in other applications.

SPP connection with RS507 as a Peripheral

1. Right click the Bluetooth icon on the computer desktop tray.

Figure 93 Bluetooth Icon In Computer Desktop Tray - SPP connection with RS507 as a Peripheral



Or

From **My Bluetooth Places** screen, select **Bluetooth Tasks** bar and select **Add a Bluetooth Device**.

Figure 94 My Bluetooth Places Screen - SPP connection with RS507 as a Peripheral

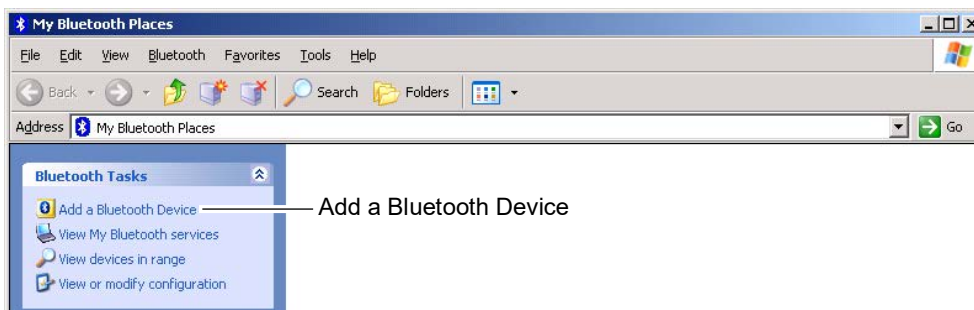

2. Check **My device set up and ready to be found** box and click **Next**.

Figure 95 Bluetooth Setup Screen - SPP connection with RS507 as a Peripheral



3. Verify that the RS507 is found by the Host, select the RS507 that you want to add and click **Next**.

Figure 96 Bluetooth Device Selection Screen - SPP connection with RS507 as a Peripheral



4. Check the **Serial Port** box and click **Next**.

Figure 97 Bluetooth Service Selection - Serial Port Screen - SPP connection with RS507 as a Peripheral

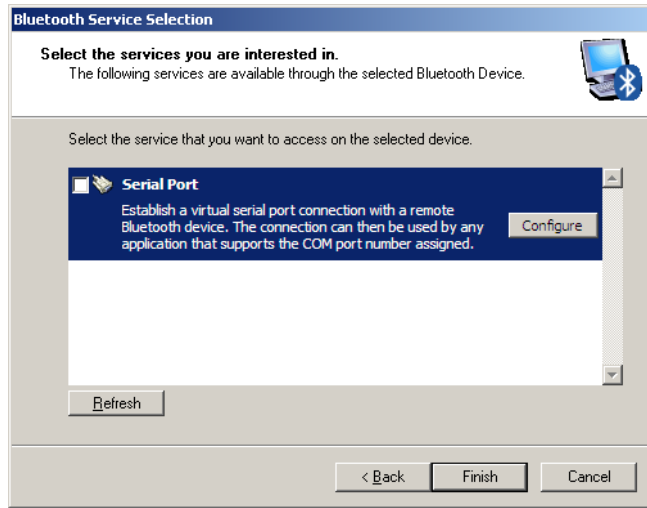

5. The Secure Simple Pairing starts and a shortcut will be created. Click **OK**.

Figure 98 Bluetooth Shortcut Confirmation Box - SPP connection with RS507 as a Peripheral

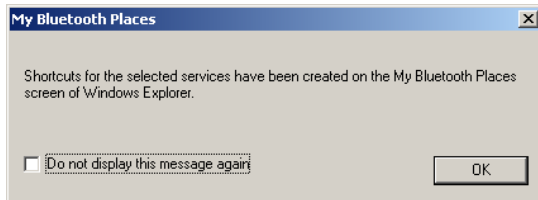

6. Once completed click **Finish**.

Figure 99 Bluetooth Setup Wizard - SPP connection with RS507 as a Peripheral



NOTE: When using an earlier Bluetooth version that is not equipped with Secure Simple Pairing, a passkey is required only for the first connection. Check the **Let me choose my own passkey** button, enter **12345** and click Next.

The RS507 is ready to scan and send bar codes over the assigned serial port.

- Find the assigned serial Outgoing port, right click the Bluetooth icon and select **Bluetooth Configuration** and the **Local Services** tab.

✓ **NOTE:** Do not confuse the Bluetooth serial port assigned as Incoming (RS507 initiates the connection) with the Bluetooth serial port assigned as Outgoing (The computer initiates the connection and RS507 is discovered - Peripheral Mode).

Figure 100 Bluetooth Configuration Screen - SPP connection with RS507 as a Peripheral

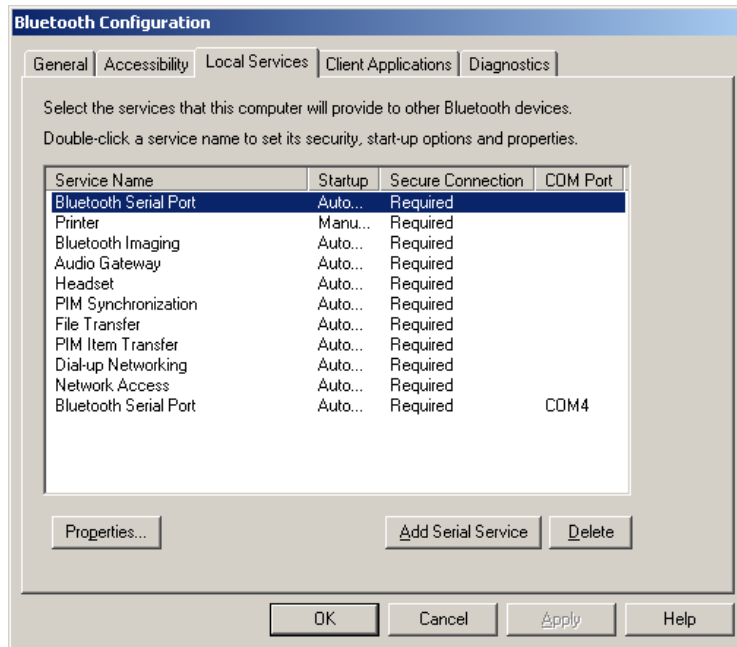

- Open the COM port assigned as Incoming COM port in the application (for example, COM7). After the COM port is opened the computer connects to the RS507 and a beep will sound. For demonstration, refer to [How to demonstrate SPP connection with a computer on page 193](#).

✓ **NOTE:** If the COM port is not opened prior to the connection, the RS507 will fail to connect. Make sure the same COM port is closed in other applications.

How to pair and connect with other devices

The RS507 can pair and connect as a serial port device using the Bluetooth SPP profile to other devices that support SPP using the device either the RS507 as a Central (recommended) or the device discovery feature.

The PC Tool application can be used to generate the Bluetooth Device (BD) address of the target device for testing. Otherwise this bar code can be printed on a label and affixed to the device.

✓ **NOTE:** Not all devices support SPP. If the RS507 is not discovered as a serial port device (camera), check with the device vendor.

Connecting to Zebra Printers

To connect the RS507 to a Zebra printer, the RS507 must be set to SPP mode and have Bluetooth security set to low. Use the following barcodes before connecting the RS507 to a Zebra printer.

SPP bar code



Low Bluetooth Security

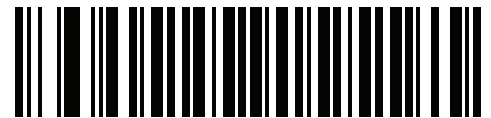

Reconnecting

Automatic reconnection

The RS507 maintains Bluetooth communication with the connected device within a range of 10 meters (30 feet). When the RS507 fails to establish connection or connection is lost during operation:

- The RS507 emits one string of low/high beeps.
- The RS507 automatically attempts to reconnect to the computer for 30 seconds (the **Scan LEDs** flash green).

Manual reconnection to Restore Lost Bluetooth Connection

If automatic re-connection fails, verify that the RS507 is within Bluetooth range and briefly press the small Restore key on the side of the RS507 to reconnect.

- The RS507 **Scan LEDs** start to flash green, indicating that the RS507 is attempting to establish connection with the computer.
- The **Scan LEDs** turn off and the RS507 emits one string of low/high beeps indicating that the RS507 is connected and ready for scanning.

✓ **NOTE:** When the RS507 is in SPP connection mode, pressing the **Restore key** after a Warm or Cold boot reconnects the RS507 to the last paired device. Connection is established as long as the link key on the device side is not deleted (the authentication key used to establish a link between devices).

How to demonstrate SPP connection with a computer

Once SPP connection is established, an application is required to demonstrate the RS507.

To scan a bar code:

1. If the RS507 is still connected to the PC Tool application, close the COM port on the PC Tool application.
2. Run a hyper terminal application such as the Tera Term application.
(<http://www.ayera.com/teraterm/download.cfm>).

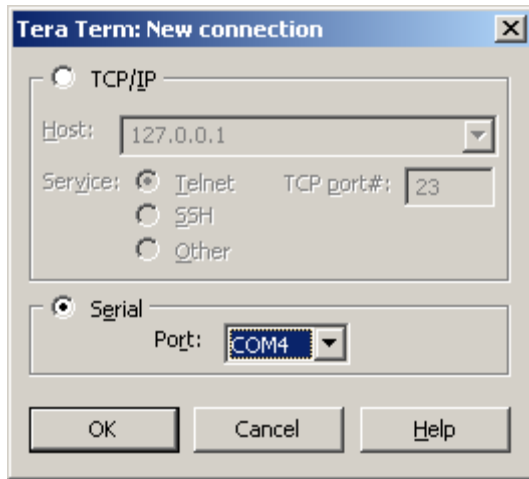
Figure 101 Tera Term Application Screen

3. Select the virtual COM port set for the RS507 connection.
4. Scan bar codes. Successful decoding of a bar code is indicated by one green flash of the **Scan LEDs** and a high beep sound. In case of Bluetooth disconnection, the RS507 emits one high beep followed by four low beeps.

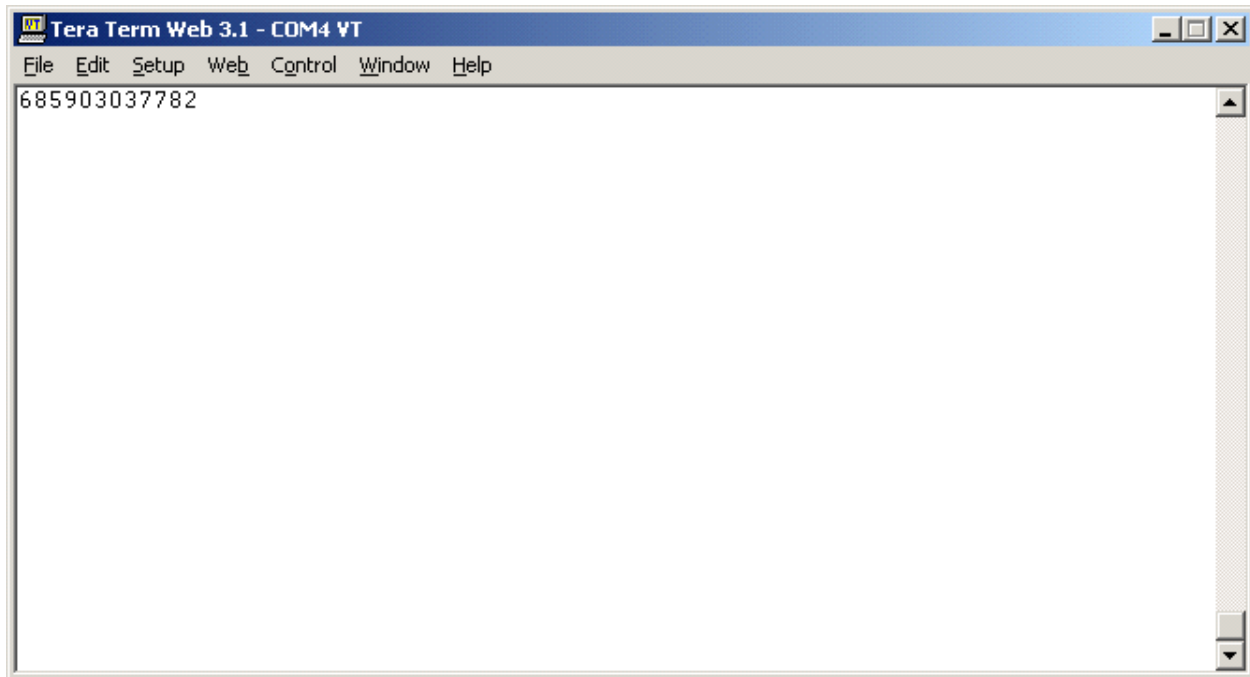
Figure 102 Tera Term Entry Screen

Connecting multiple RS507 into single device

Multiple RS507 units can be connected a single computer running an application that accepts more than one RS507, each with its own assigned COM port. The number of RS507 units concurrently connected is depended on the computer's Bluetooth stack.

Special characters

SPP mode supports special characters that trigger actions when sent from the computer.

Table 15 Special Characters

Character	ASCII	Action
BELL	0x07	If Bell Indication is enabled, performs the configured Bell Indication.
Serial	0x73	Sends the serial number of the RS507.
Image Capture Mode	0x69	Activates Image Capture mode.
Custom notification 1	0x79	Performs custom notification sequence 1.
Custom notification 2	0x63	Performs custom notification sequence 2.

How to return to SSI (SCAN) mode

To change the RS507 to SSI (SCAN) mode:

1. Perform Clean Boot to the RS507:
 - Remove the battery from the RS507.
 - Press and hold the Restore key.
 - Install the Battery onto the RS507.
 - Keep holding the Restore key pressed for about five seconds until a chirp is heard and the **Scan LEDs** flash green.

2. Scan the SSI (SCAN) bar code.

SSI (SCAN) bar code



3. Perform a Cold Boot by removing and re-installing the battery onto the RS507. The RS507 starts to operate under SSI (SCAN) for connection to Zebra terminals.

Switching between SSI (SCAN), HID and SPP

To switch the RS507 from one mode to another:

1. Perform Clean Boot to the RS507:
 - Remove the battery from the RS507.
 - Press and hold the Restore key.
 - Install the Battery onto the RS507.
 - Keep holding the Restore key pressed for about five seconds until a chirp is heard and the **Scan LEDs** flash green.

2. Scan the required profile bar code (see the following bar codes).

SPP bar code



SSI (SCAN) bar code



HID bar code



3. Perform a Cold Boot by removing and re-installing the battery onto the RS507 (see [Cold Boot on page 164](#)). The RS507 starts to operate and is also discoverable as a keyboard (HID) or serial device (SPP).

IMPORTANT: In Win 7 SP1, when switching between SPP connection and HID connection and vice versa, the RS507 device must be removed from the computer pairing list.

4. Remove the RS507 from the computer Bluetooth stack by right clicking the Bluetooth icon and selecting **Show Bluetooth Devices**

Figure 103 Computer Bluetooth Stack Screen - Switching Between SSI (SCAN), HID and SPP

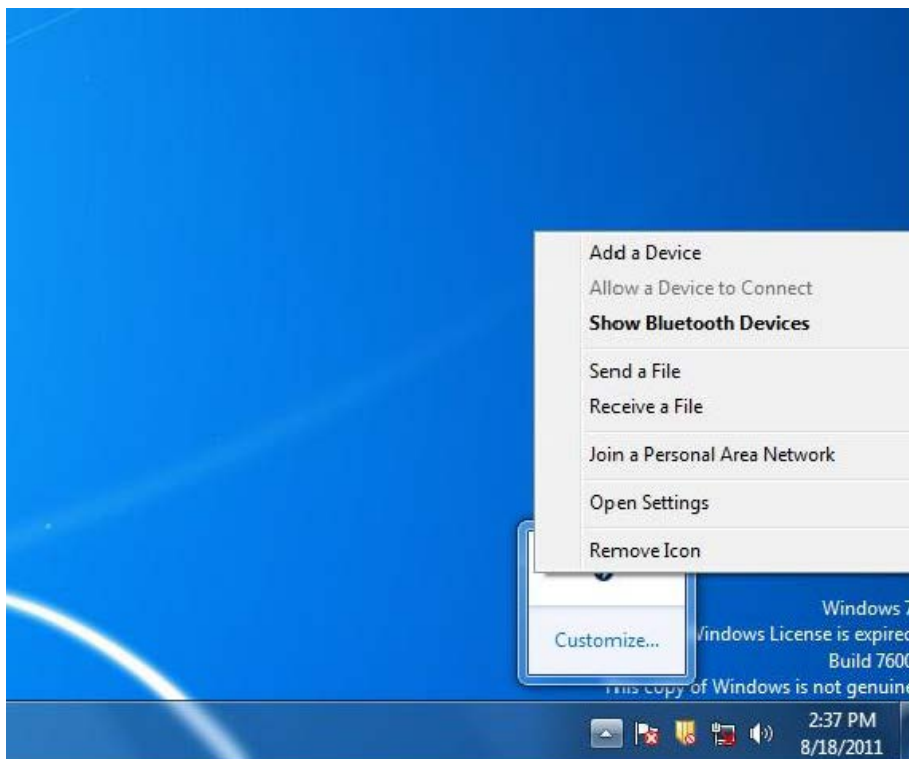

5. Right click the RS507 icon (camera icon) and select **Remove device**

Figure 104 Device Screen - Switching Between SSI (SCAN), HID and SPP

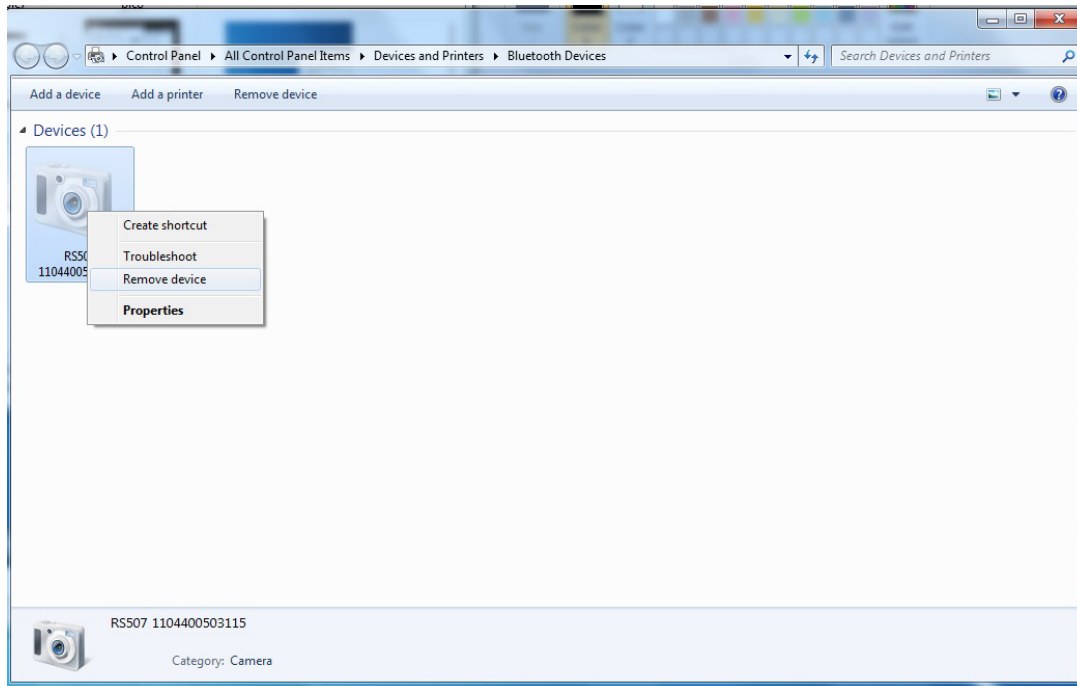

IMPORTANT: In Win XP SP3:, when switching between SPP connection and HID connection and vice versa, the RS507 device must be removed from the computer pairing list, to remove the RS507 please do as follow:

6. Remove the RS507 from the Bluetooth stack by selecting it on the **My Bluetooth Places > Entire Bluetooth Neighborhood**, right click and select **Disable**.

Figure 105 Entire Bluetooth Neighborhood Screen - Switching Between SSI (SCAN), HID and SPP

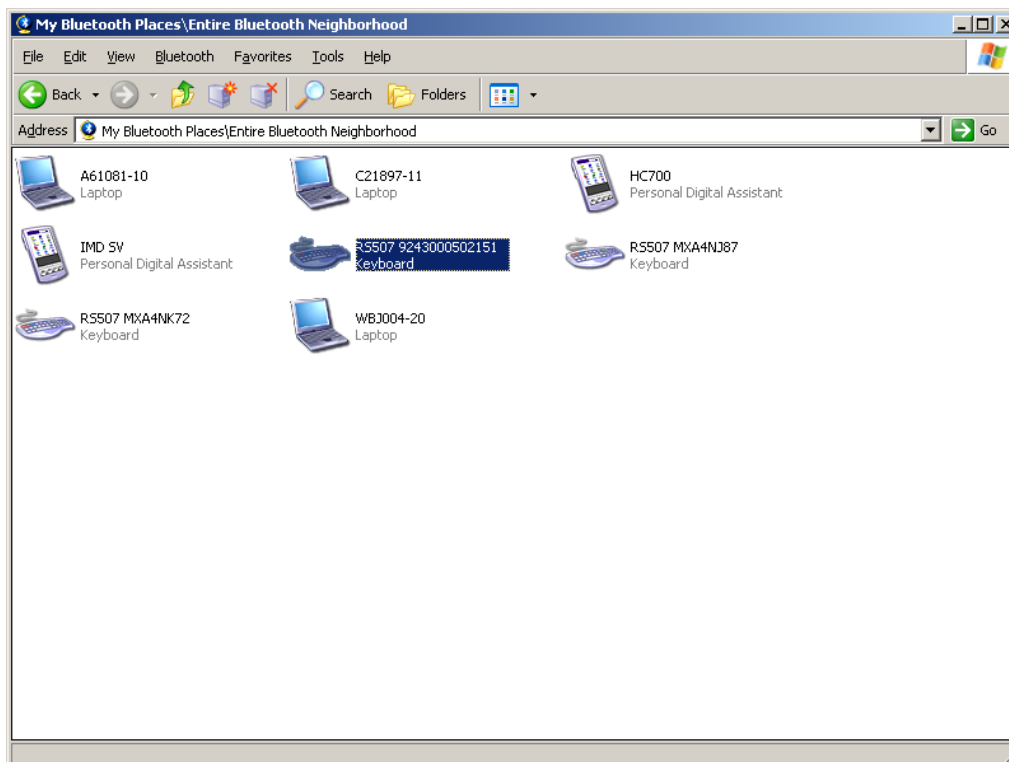

Firmware upgrade

Upgrading using a computer and the PC Tool application

Older RS507 devices can be upgraded and re-flashed with a new firmware. The update is performed by downloading the firmware to the RS507 flash memory. If download fails, the previous firmware remains operational.

The firmware remains inside the RS507 memory even when powering the RS507 off/on (removing and re-installing the battery).

To update the firmware of the RS507:

1. Install a fully charged RS507 battery and wait until the RS507 emits a beep and stops, indicating that the power up process is completed.
2. Press the Scan trigger and verify that the Scan LEDs illuminate and the aimer light is shown while the scan trigger is pressed.
3. Establish SSI connection by scanning the SSI (SCAN) bar code to change the RS507 mode to SSI (SCAN) mode. The SSI (SCAN) mode allows the RS507 to communicate with the computer through SPP during the firmware update session. The SSI (SCAN) bar code can also be scanned directly from a computer screen.

SSI (SCAN) bar code

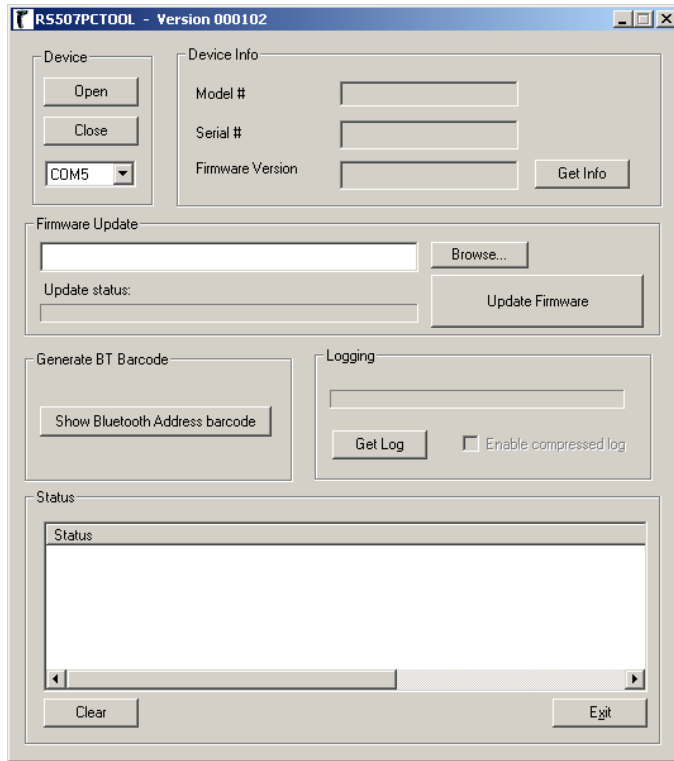

4. Perform a Cold Boot by removing and re-installing the battery onto the RS507. The RS507 starts to operate under SSI mode using an SPP connection with the computer. Notice the COM port that was assigned to the RS507.
5. On the computer, run the PC Tool application.

Figure 106 PC Tool Application - Firmware Upgrade

✓ **NOTE:** When using older Bluetooth version, enter PIN code **12345**.

6. Follow the instructions for [SPP connection with RS507 as a Central on page 179](#) under Windows 7 SP1 or [SPP connection with RS507 as a Central on page 185](#) under Windows XP SP3 except, this time use it while the RS507 is in SSI (SCAN) mode.
7. Once paired and connected to the computer, select Bluetooth COM port.
8. Click the **Open** button. The RS507 information is displayed on the Device Info fields.

Figure 107 PC Tool Application Device Info fields - Firmware Upgrade

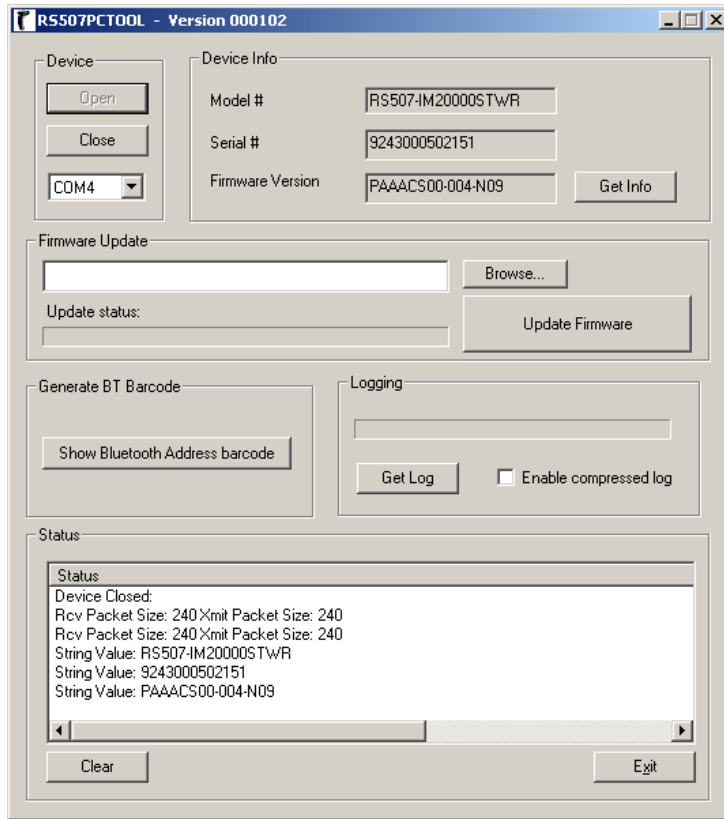

9. Press the **Browse** button, select the RS507 firmware dat file (for example: PAAACS00-004-N09D0.dat) and press the **Open** button.

Figure 108 Firmware Update - dat File

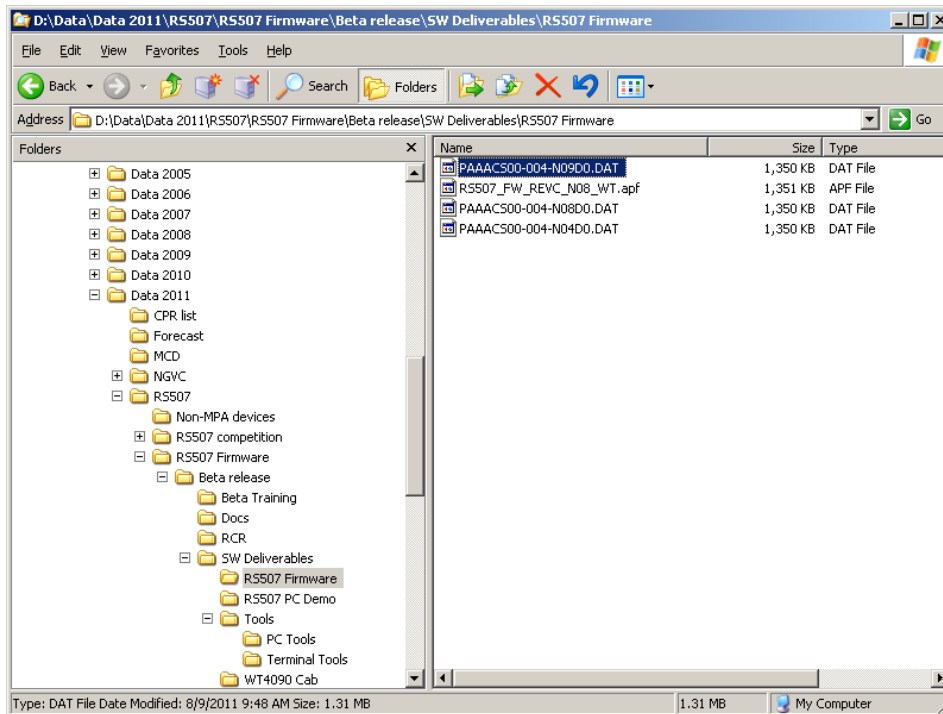

10. Press the **Update Firmware** button to start the firmware update process.

Figure 109 Firmware Update - Start Process

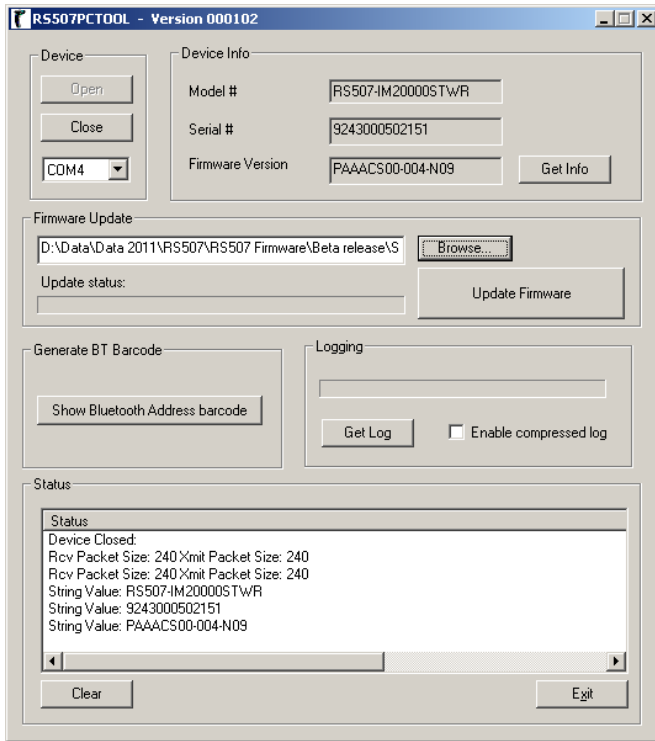

11. If the battery level is too low, the firmware update will not start. In such case, replace the battery with a fully charged battery, close the Com port, re-open the Com port and again, start to download.

Figure 110 Download Screen - PC Tool Application

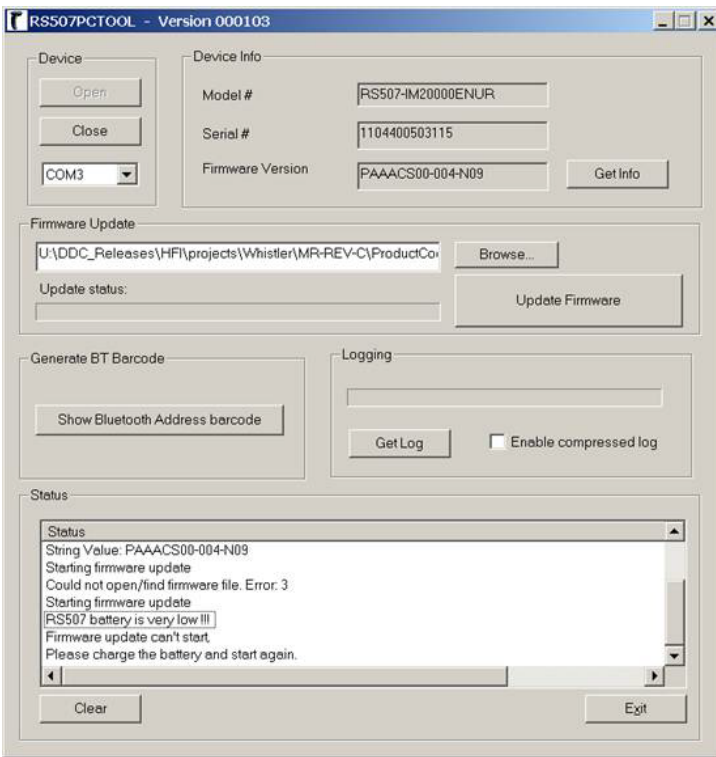

12. During firmware update, the RS507 Scan LEDs blink red. When the firmware update successfully ends, wait for RS507 internal flash programming to complete (the Scan LEDs turn off).
At the end of the firmware update, the RS507 performs Warm Boot (see [Warm Boot on page 164](#)).
13. Perform Clean Boot to the RS507:
 - Remove the battery from the RS507.
 - Press and hold the Restore key.
 - Install the battery onto the RS507.
 - Keep holding the Restore key pressed for about five seconds until a chirp is heard and the Scan LEDs flash green.

At this point, the RS507 firmware is updated and ready for connection with the updated firmware.

- ✓ **NOTE:** After Clean Boot is performed, the RS507 defaults are changed to SSI (SCAN) mode to interface to Zebra terminals.

Upgrading with a Zebra terminal

Firmware update utility application was included in the CAB files provided for WT40x0, MC9090, MC709x, MC3090 and VC5090. For step-by-step instructions, refer to *<Blue><Italic>Imager Firmware Update on page 8-62*.

For firmware update of other terminals, use the PC Tool application.

Retrieving the RS507 log file

The events of the RS507 software log includes debug information and SW diagnostics logged during the RS507 operation. The log is saved on the RAM of the RS507 and is lost once the RS507 battery is removed.

To retrieve the RS507 log file:

1. If the RS507 is stuck or do not behave as expected once connected to the application, do not remove the battery. Instead, perform a Warm Boot by pressing and holding the Restore Key for more than six seconds.
2. Establish SSI connection by scanning the SSI (SCAN) bar code to change the RS507 mode to SSI (SCAN) mode. The SSI (SCAN) mode allows the RS507 to communicate with the computer through SPP during the firmware update session. The SSI (SCAN) bar code can also be scanned directly from a computer screen.

SSI (SCAN) bar code



3. Perform a Warm Boot by pressing and holding the Restore Key for more than six seconds. The RS507 starts to operate under SSI (SCAN) using an SPP connection with the computer.
4. Locate the COM port that was assigned to the RS507.
5. On the computer, run the PC Tool application.

Figure 111 PC Tool Application Screen

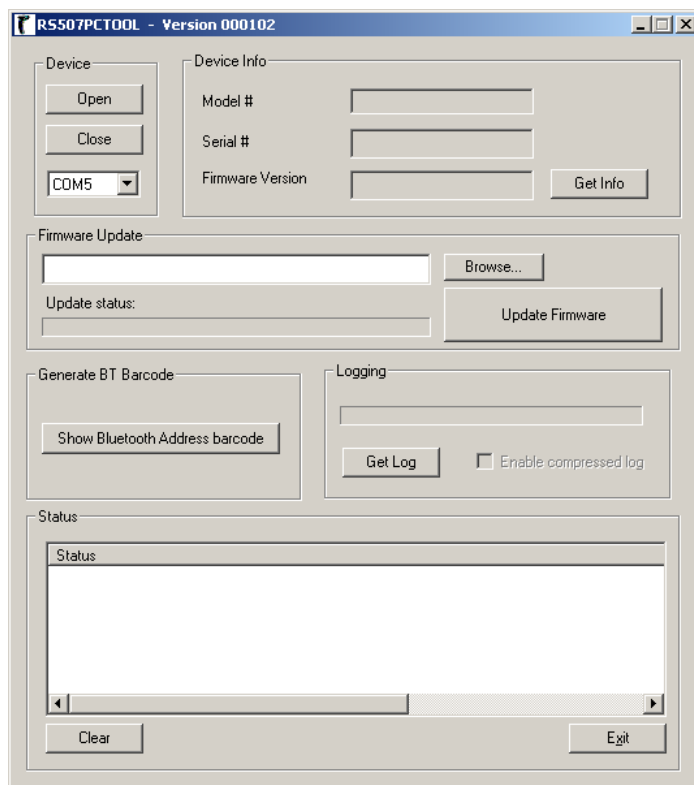

6. Click the **Show Bluetooth Address barcode** button.
7. Manually enter the computer BD address and click the **Generate** button.

Figure 112 Bar Code Generator - PC Tool Application

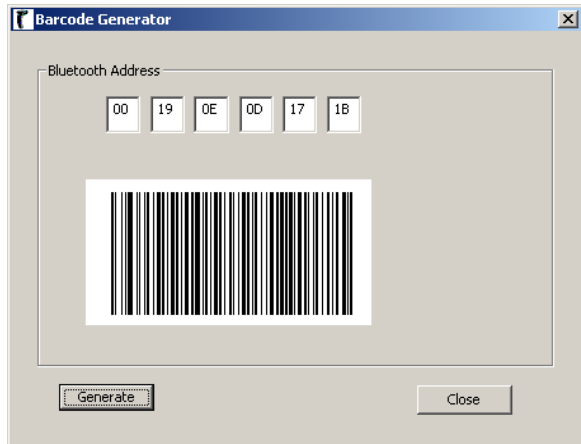

✓ **NOTE:** The PC Tool application retains the last BD address entered so next time press the **Generate** button to recreate the bar code image.

8. To start the connection process, aim the RS507 at about 7" (18 cm) away from the front of the computer screen and scan the bar code of the computer (or the other target device) BD address. The RS507 **Scan LEDs** start flashing green indicating that the RS507 is attempting to establish connection with the computer.
9. If the following Windows pops up, check the box **Always allow this device to access this service** and click **OK**.



10. The RS507 bleeps, establishes the SSI over SPP connection and is ready log file retrieval.



11. Select Bluetooth COM port assigned to the RS507.

✓ **NOTE:** The RS507 can connect to a computer or other device that supports Bluetooth Serial Port Profile interface as either a Central (the RS507 initiate the connection) or a Peripheral (the computer or other device initiate the connection and the RS507 is discovered by the computer).

12. Click the **Open** button - the application displays the RS507 status information.

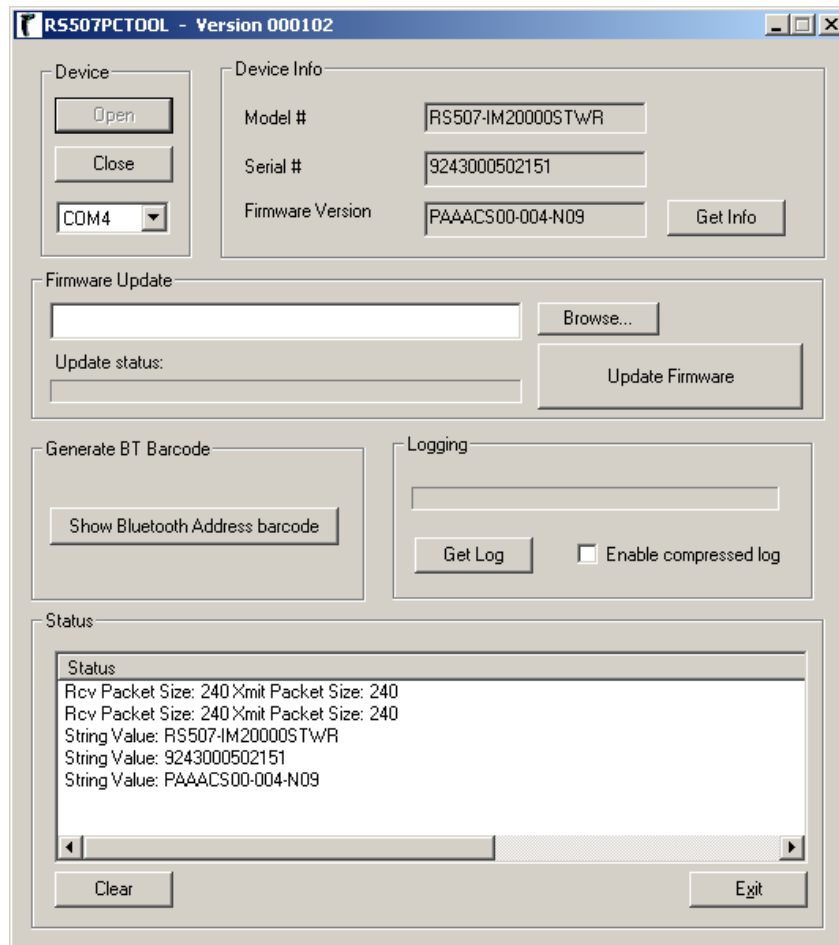
Figure 113 RS507 Status Information - PC Tool Application

13. Click the **Get Log** button to download the RS507 log file.
14. When you expect a large log file, check the **Enable compress log** to get a compressed log file in .zip format. The log file is saved on the computer at the same folder of the PC Tool application.
15. from the same directory of the PC Tool application.

Figure 114 Retrieve RS507 Log File - PC Tool Application

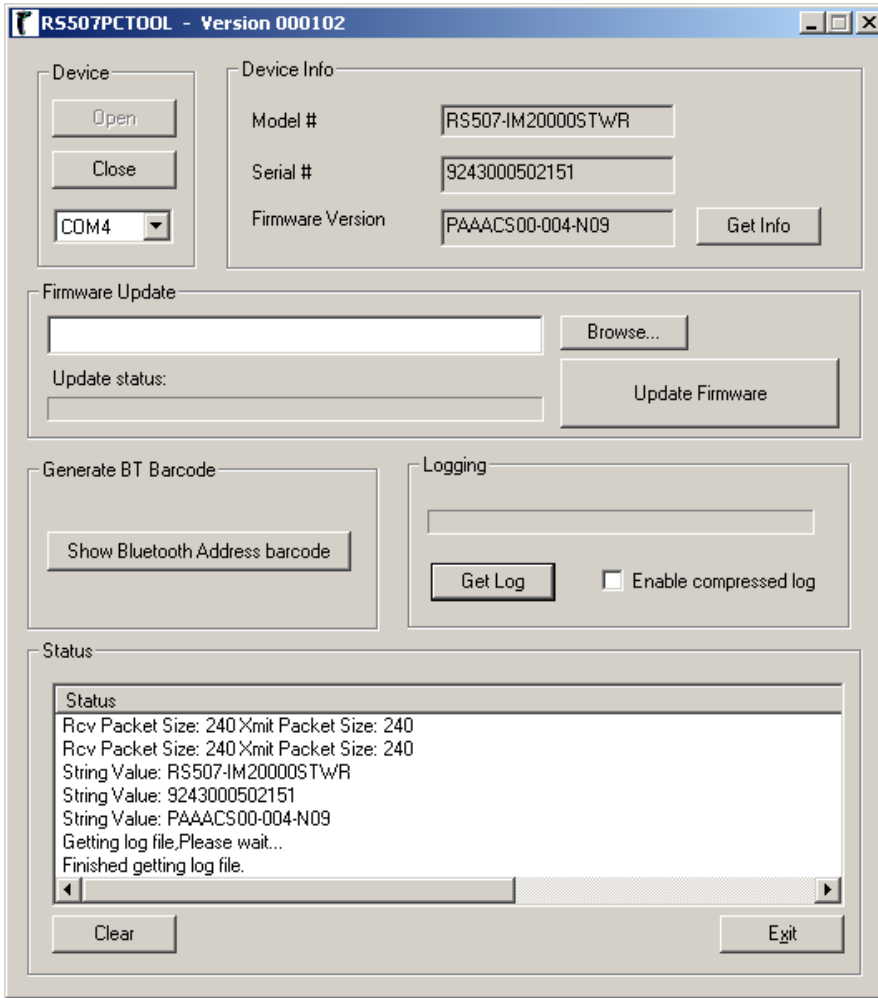

Bluetooth Bar Codes

✓ **NOTE:** Bar codes marked with * Indicate default configuration.

Bluetooth Authentication Control

Bluetooth Authentication

The Bluetooth Authentication parameter enables/disables Bluetooth authentication connection.

Disable



*Enable



Bluetooth Automatic Reconnection Control

Bluetooth Auto Reconnection

The Bluetooth Auto Reconnection parameter sets Bluetooth automatic reconnection when unexpected Bluetooth disconnection occurs.

*None



On power up



On out of range



Both on power up or out of range



Reconnect Attempts Timeout

The Reconnect Attempts parameter defines the auto reconnect attempt time duration after Bluetooth disconnection.

*30 seconds



35 seconds



40 seconds



45 seconds



50 seconds



55 seconds



60 seconds



Force Pairing Save

The Force Pairing Save parameter enables/disables saving the remote Bluetooth address after each Bluetooth connection attempt.

When this parameter is disabled, the Bluetooth address is saved only after a successful Bluetooth connection. If the Bluetooth connection fails, the Bluetooth address is not saved.



NOTE: This parameter is effective when the RS507 connects as Central.

Disable



*Enable



Bell Indication Control

BELL Indication (SPP mode only)

The BELL Indication parameter configures the beep tone sequence of the bell indication when a bell character is received. This feature is valid only in SPP mode for PC connection.

*Disable

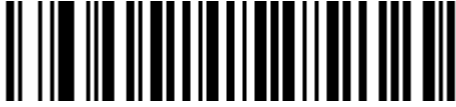

Enable



GP_1_HI_SHORT



GP_2_HI_SHORT



GP_3_HI_SHORT

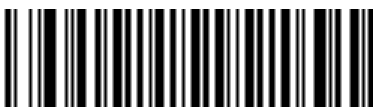

GP_4_HI_SHORT

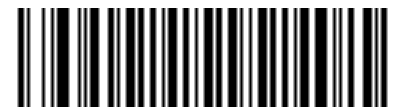

GP_5_HI_SHORT



GP_1_LO_SHORT



GP_2_LO_SHORT



GP_3_LO_SHORT



GP_4_LO_SHORT



GP_5_LO_SHORT



GP_1_HI_LONG



GP_2_HI_LONG



GP_3_HI_LONG



GP_4_HI_LONG



GP_5_HI_LONG



GP_1_LO_LONG



GP_2_LO_LONG



GP_3_LO_LONG



GP_4_LO_LONG



GP_5_LO_LONG

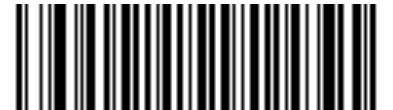

GP_FAST_WARBLE



GP_SLOW_WARBLE



GP_HI_LO



GP_LO_HI



GP_HI_LO_HI



GP_LO_HI_LO



GP_HI_HI_LO_LO



APP_ERROR_BEEP



APP_CLICK



LOW_CLICK



Bluetooth HID Country Keyboard Types (Country Codes)

Scan the bar code corresponding to the keyboard type.



***North American Standard Keyboards**



French Windows



German Windows



French Canadian Windows 98



Spanish Windows



Italian Windows



Swedish Windows



UK English Windows



Japanese Windows



French Canadian Windows 2000/XP



Portuguese/Brazilian Windows

Bluetooth Profile Control

To configure the RS507 to a Bluetooth Connection Mode:

1. Scan the required profile bar code (see the following bar codes).
2. Perform a cold boot by removing and re-installing the battery onto the RS507. The RS507 starts to operate and is also discoverable as a keyboard (HID) or serial device (SPP).

SPP bar code



HID bar code



Scan bar code



Bluetooth Pairing Control

Remove Bluetooth Connection

Remove the Bluetooth connection to allow the RS507 to connect to another PC or before switching the RS507 to a different connection profile.

To remove the Bluetooth connection, scan an un-pairing bar code to disconnect the RS507 from the PC.

Un-pairing bar code Label



The RS507 emits one string of high/low beeps indicating that Bluetooth communication with the PC is removed.

Another way to remove a Bluetooth connection is removing and re-installing the RS507 battery.

Bluetooth Security Level Control

- **Low Bluetooth Security** - The low security setting is designed for ease of connection with most devices. This setting may be unacceptable to some devices. If connection fails, try re-connecting after increasing security setting on the RS507.
- **High Bluetooth Security** - The high security setting enables Man in the Middle protection for Bluetooth 2.1 and above. Not all devices are able to support this mode.

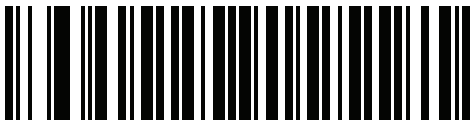

Low Bluetooth Security

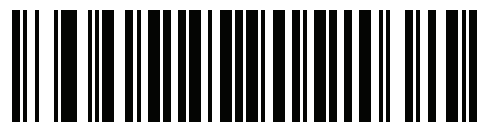

*High Bluetooth Security

Batch Mode

Parameter # 544



IMPORTANT: Batch mode only applies for SPP mode.

When the RS507 is configured for any of the batch modes, it attempts to store bar code data (not parameter bar codes) until transmission is initialized, or the maximum number of bar codes are stored. When a bar code is saved successfully, a good decode beep sounds and the LED flashes green.

The RS507 can store up to 30,720 bytes of barcode data in memory. The size of each barcode equals the total of: the bytes in the ADF rule, the bytes in the barcode, plus three more bytes.



NOTE: Since all the data stored in the batch mode buffer is transmitted as a stream, it is recommended to add an Enter key (or any other distinctive key) as a suffix to the barcode.

Modes of Operation

- **No Batch Mode (default)** - Do not batch data. The RS507 attempts to transmit every scanned bar code.
- **Out of Range Batch Mode** - The RS507 starts storing bar code data when it loses its connection to a remote device (for example, when a user holding the RS507 walks out of range). Data transmission is triggered by re-establishing the connection with the remote device (for example, when a user holding the RS507 walks back into range).
- **Standard Batch Mode** - The RS507 starts storing bar code data and sending stored bar code data when the appropriate program barcode is scanned.



NOTE: Transmission is halted if the connection to the remote device is lost.

In all modes, transmissions are halted if the RS507 is moved out of range. The RS507 resumes when it is back in range. If a bar code is scanned while batch data is transmitted it is appended to the end of the batched data; parameter bar codes are not stored.



*No Batch Mode



Out of Range



Standard Batch Mode



Enter Batch Mode



Send Batch Data

Unique Identifier

When using Batch Mode, enable Unique Identifier to add the device serial number to each payload data sent in Batch Mode.



***Disable**



Enable

Force Bluetooth Role Switch (SPP only)

When Force Bluetooth Role Switch is enabled, the RS507 forces a role switch with the remote device and becomes a slave of the SPP connection. This allows a remote device to have multiple slave devices on a single Bluetooth piconet.



***Disable**



Enable

Image Capture (SPP only)

Image Capture mode allows the RS507 to capture an image and send the binary data over the SPP connection. The connected device uses the binary data, starting from the JPG signature (hex value FF D8 FF), to create the image file in JPG format.

To use Image Capture mode:

1. Change the RS507 to SPP mode. See [Serial Port Profile \(SPP\) Mode on page 178](#).
2. Pair and connect the RS507 to a device.
3. Enable Image Capture mode by sending the character **i** to the RS507. See [Special characters on page 195](#).
The cross hair laser beam illuminates, indicating that the RS507 is ready to capture an image.
4. Press the Scan trigger.

After capturing an image the RS507 performs the following in order:

- Sends the data to the connected device
- Exits Image Capture mode
- Returns to the previous bar code scanning mode.

HID Features for Apple iOS (HID Only)

This option works with Apple iOS devices to enable the opening and closing of the iOS virtual keyboard by pressing the Restore key.



NOTE: When this feature is enabled, the RS507 may be incompatible with non-Apple iOS devices.



***Disable**
(0)



Enable
(1)

123Scan and Software Tools

Introduction

This chapter briefly describes the Zebra software tools available for customizing scanner operation.

123Scan

123Scan is a software tool that simplifies scanner setup and more.

Intuitive enough for first time users, the 123Scan wizard guides users through a streamlined setup process. Settings are saved in a configuration file that can be printed as a single programming barcode for scanning, emailed to a smart phone for scanning from its screen, or downloaded to the scanner using a USB charging cradle.

Through 123Scan a user can:

- Configure a scanner using a wizard.
 - Program the following scanner settings.
 - Beeper tone / volume settings.
 - Enable / disable symbologies.
 - Communication settings.
 - Modify data before transmission to a host using:
 - Advanced Data Formatting (ADF) - Scan one barcode per trigger pull.
- Load parameter settings to a scanner via the following.
 - Barcode scanning.
 - Scan a paper barcode.
 - Scan a barcode from a PC screen.
 - Scan a barcode from a smart phone screen.

For more information go to: zebra.com/123Scan.

Communication with 123Scan

Use a USB cable to connect the scanner to a Windows host computer running 123Scan.

123Scan Requirements

- Host computer running Windows XP, 7, 8, and 10
- Scanner

123Scan Information

For more information on 123Scan, go to: zebra.com/123Scan

For a 1 minute tour of 123Scan, go to: zebra.com/ScannerHowToVideos

To see a list of all of our software tools, go to: zebra.com/scannersoftware

Advanced Data Formatting (ADF)

Advanced Data Formatting (ADF) allows customizing data before transmission to the host device. Use ADF to edit scanned data to suit the host application's requirements. With ADF you scan one barcode per trigger pull. ADF is programmed using 123Scan.

For a video on Creating an Advanced Data Formatting (ADF) Rule using 123Scan, go to: zebra.com/ScannerHowToVideos.

For additional information, refer to the Advanced Data Formatting Programmer Guide.

Specifications

Technical Specifications

Imager

Table 16 Imager Technical Specifications

Item	Description
Physical Characteristics	
Dimensions (H x W x L):	Triggerless, standard battery: 2.9 x 5.3 x 7.4 cm/1.16 x 2.1 x 2.92 in. Triggerless, extended battery: 3.6 x 5.3 x 7.4 cm/1.42 x 2.1 x 2.92 in. Triggered, standard battery: 2.9 x 5.3 x 7.4 cm /1.16 x 2.1 x 2.92 in. Triggered, corded (cord length not included): 3.3 x 5.3 x 7.4 cm/1.3 x 2.1 x 2.92 in.
Weight:	Triggerless, standard battery = 137 g / 4.83 oz. Triggerless, extended battery = 160 g / 5.64 oz. Triggered, standard battery = 143 g / 5.04 oz. Triggered, extended battery = 166 g / 5.85 oz. Triggered, corded = 155 g / 5.47 oz.
Performance Characteristics	
Optical Resolution:	WVGA 752 H x 480 V pixels (gray scale)
Roll:	360°
Pitch Angle:	± 60° from normal
Skew Tolerance:	± 60° from normal
Aiming Element:	655 nm ± 10 nm Visible Laser Diode
Illumination Element	25 nm ± 5 nm Red LEDs
Field of View:	Horizontal: 39.6°; Vertical: 25.7°

Specifications

Item	Description																																													
Nominal Working Distance from exit window:	<table style="width: 100%; border-collapse: collapse;"> <tr> <td style="width: 15%;">Density:</td> <td style="width: 15%;">5 mil</td> <td style="width: 15%;">7.5 mil</td> <td style="width: 15%;">20 mil</td> <td style="width: 15%;">13 mil</td> </tr> <tr> <td>1D Code Type:</td> <td>39</td> <td>39</td> <td>39</td> <td>UPC</td> </tr> <tr> <td>Near:</td> <td>2 inches</td> <td></td> <td></td> <td>1.5 inches</td> </tr> <tr> <td>Far:</td> <td>7.4 inches</td> <td>10.5 inches</td> <td>24.6 inches</td> <td>15.4 inches</td> </tr> <tr> <td colspan="5"> </td> </tr> <tr> <td>Density:</td> <td>6.67 mil</td> <td>10 mil</td> <td>15 mil</td> <td></td> </tr> <tr> <td>2D Code Type:</td> <td>PDF417</td> <td>PDF417</td> <td>PDF417</td> <td></td> </tr> <tr> <td>Near:</td> <td>3.3 inches</td> <td></td> <td></td> <td></td> </tr> <tr> <td>Far:</td> <td>7.0 inches</td> <td>10 inches¹</td> <td>4.6 inches</td> <td></td> </tr> </table>	Density:	5 mil	7.5 mil	20 mil	13 mil	1D Code Type:	39	39	39	UPC	Near:	2 inches			1.5 inches	Far:	7.4 inches	10.5 inches	24.6 inches	15.4 inches						Density:	6.67 mil	10 mil	15 mil		2D Code Type:	PDF417	PDF417	PDF417		Near:	3.3 inches				Far:	7.0 inches	10 inches ¹	4.6 inches	
Density:	5 mil	7.5 mil	20 mil	13 mil																																										
1D Code Type:	39	39	39	UPC																																										
Near:	2 inches			1.5 inches																																										
Far:	7.4 inches	10.5 inches	24.6 inches	15.4 inches																																										
Density:	6.67 mil	10 mil	15 mil																																											
2D Code Type:	PDF417	PDF417	PDF417																																											
Near:	3.3 inches																																													
Far:	7.0 inches	10 inches ¹	4.6 inches																																											
Ambient Light Immunity:	<p>From total darkness</p> <p>Indoor: 450 ft. candles (4,845 lux).</p> <p>Outdoor: 9,000 ft. candles (96,900 lux).</p>																																													
Motion Tolerance:	63.5 cm (25 inches) per second, typical.																																													
Supported Symbologies	<p>1D enabled by default:</p> <p>Codabar, Code 39, Code 128, EAN-13, EAN-8, Interleaved 2 of 5, UPC-A and UPC-E.</p> <p>1D disabled by default:</p> <p>Code 11, Code 32 Pharmaceutical (PARAF), Code 93, MSI, Reduced Space Symbology (RSS-14, RSS Limited, RSS Expanded), Straight 2 of 5 IATA (two-bar start/stop), Straight 2 of 5 Industrial (three-bar start/stop), Trioptic, UPC-E1.</p> <p>2D enabled by default:</p> <p>4-CB (4-State Customer Bar code), Aztec, MicroPDF417, PDF417, MaxiCode.</p> <p>2D disabled by default:</p> <p>Australian Post, British Post (4 state code and “infomail”), Data Matrix, Japanese Post, KIX (Netherlands) Post, Planet Code, Postnet, QR Code, EAN•UCC Composite, TCIF Linked Code 39 (TLC39).</p>																																													
Supported Aiming Modes:	Class 2 Laser, cross hair with bright center for sunlight visibility; Pick List mode option.																																													
Interface:	<p>Cordless:</p> <p>Bluetooth: Class II, v 2.1 with Adaptive Frequency Hopping (AFH).</p> <p>Supported profiles: Serial Port Profile (SPP), Human Interface Device Profile (HID), Service Discovery Application Profile (SDAP).</p> <p>Pairing: by reading terminal Bluetooth address as bar code off the display or from a printed label.</p> <p>Corded (to WT4XXX): Serial.</p>																																													

Specifications

Item	Description
Field Replaceable Parts:	Batteries, corded adaptor, trigger clamp, triggerless clamp, comfort pad, straps and strap buckle.
User Interface	
LED:	Two (parallel), multi color, rear left and rear right.
Beeper:	Rear center, up to 80 dBA SPL @ 10 cm.
Restore Key:	User accessible for emergency boot up and Bluetooth reconnect (after excessive disconnection period).
Scan Triggering:	Manual or automatic using Interactive Sensing Technology (IST).
User Environment	
Operating Temperature:	-20° to 55° C/-4° to 131° F.
Storage Temperature:	-40° to 70° C/-40° to 158° F excl. Battery -40° to 60° C/-40° to 140° F incl. Battery
Humidity:	5% to 85% (non-condensing).
Drop Specification:	6 ft./1.8 m multiple drops to concrete across operating temperature range.
Sealing:	IP54
Electrostatic Discharge (ESD):	±15kV air discharge, ±8kV direct discharge.
Power	
Cordless:	Standard battery: Li-Ion 970 mAh, 3.7 V with up to 35,000 scans (continuous) or up to 10 hours with 900 scans per hour on a single charge using fresh batteries. Extended battery: Li-Ion 1940 mAh, 3.7 V with up to 70,000 scans (continuous) or up to 20 hours with 900 scans per hour on a single charge using fresh batteries.
Corded:	Corded adapter to WT4XXX
Software Compatibility	
	DataWedge; Wavelink's Terminal Emulation (TE), among others.
Peripherals and Accessories	
Battery charger:	Charger accommodates eight standard and extended batteries simultaneously each with LED indicator and battery age test.
Regulatory	
Electrical Safety:	Certified to UL60950-1, CSA C22.2 No. 60950-1, EN60950-1, IEC 60950-1.
Laser Safety:	CDRH Class II, IEC 60825-1 Class 2.
EMI/RFI:	FCC Part 15 Class B, ICES-003 Class B, European Union EMC and R&TT. Directives, Australian AS/NZS 60950.1.

Specifications

Item	Description
RoHS:	Compliance with RoHS standards.

8 Slot Battery Charger

Table 17 Technical Specifications

Item	Description
Physical Characteristics	
Dimensions (H x W x L):	10.2 x 11.4 x 26.6 cm (4.02 x 4.49 x 10.50 in.) without cord and external power supply.
Performance Characteristics	
Charging Duration:	Less than 4 hours (for both standard and extended capacity batteries).
User Interface	
LED:	One Bi color LED per charging bay.
Age Test Key	Activate age test cycle for docked batteries.
User Environment	
Operating Temperature:	0° to 50° C/32° to 122° F (charging is performed until battery temperature is 45° C/113° F)
Storage Temperature:	-40° to 85° C/-40° to 158° F
Humidity:	5% to 85% (non-condensing)
Electrostatic Discharge (ESD):	±15kV air discharge, ±8kV direct discharge.
Power	
External Power Supply:	AC Input: 90-264 V AC 50-60 Hz with IEC320 C8 AC inlet DC Output: 12 V/4.17A
Peripherals and Accessories	
RS507 Batteries:	Charges and tests both standard and extended capacity RS507 batteries.
Regulatory	
Electrical Safety:	Certified to UL60950-1, CSA C22.2 No. 60950-1, EN60950-1, IEC 60950-1
EMI/RFI:	FCC Part 15 Class B, ICES-003 Class B
RoHS:	Compliance with RoHS standards.

Standard Default Parameters

Standard Default Parameters Table

Table 18 Standard Default Parameters Table

Parameter	Parameter Number	Default	Page Number
User Preferences			
Set Default Parameter		Set Defaults	68
Parameter Bar Code Scanning	ECh	Enabled	69
Beep After Good Decode	38h	Enabled	69
Beeper Tone	91h	Medium	70
Beeper Volume	8Ch	High	71
Picklist Mode	F0h 92h	Disabled	73
Fuzzy 1D Processing	F1h 02h	Enabled	74
Decoding Illumination	F0h, 2Ah	Enabled	75
UPC/EAN			
UPC-A	01h	Enabled	90
UPC-E	02h	Enabled	90
UPC-E1	0Ch	Disabled	90
EAN-8/JAN 8	04h	Enabled	91
EAN-13/JAN 13	03h	Enabled	92
Bookland EAN	53h	Disabled	92
Decode UPC/EAN/JAN Supplementals (2 and 5 digits)	10h	Ignore	93
User-Programmable Supplementals			96
Supplemental 1:	F1h 43h		
Supplemental 2:	F1h 44h		

Standard Default Parameters

Table 18 Standard Default Parameters Table (Continued)

Parameter	Parameter Number	Default	Page Number
UPC/EAN/JAN Supplemental Redundancy	50h	10	96
Decode UPC/EAN/JAN Supplemental AIM ID	F 1h A0h	Combined	97
Transmit UPC-A Check Digit	28h	Enabled	97
Transmit UPC-E Check Digit	29h	Enabled	98
Transmit UPC-E1 Check Digit	2Ah	Enabled	98
UPC-A Preamble	22h	System Character	98
UPC-E Preamble	23h	System Character	99
UPC-E1 Preamble	24h	System Character	100
Convert UPC-E to A	25h	Disabled	101
Convert UPC-E1 to A	26h	Disabled	102
EAN-8/JAN-8 Extend	27h	Disabled	105
Bookland ISBN Format	F 1h 40h	ISBN-10	104
UCC Coupon Extended Code	55h	Disabled	105
ISSN EAN	F 1h 69h	Disabled	105
Code 128			
Code 128	08h	Enabled	106
Set Length(s) for Code 128	D1h D2h	Any Length	106
GS1-128	0Eh	Enabled	107
ISBT 128	54h	Enabled	108
ISBT Concatenation	F 1h 41h	Disabled	109
Check ISBT Table	F 1h 42h	Enabled	110
ISBT Concatenation Redundancy	DFh	10	110
Code 39			
Code 39	00h	Enabled	111
Trioptic Code 39	0Dh	Disabled	111
Convert Code 39 to Code 32 (Italian Pharmacy Code)	56h	Disabled	112
Code 32 Prefix	E7h	Disabled	112
Set Length(s) for Code 39	12h 13h	2 to 55	113
Code 39 Check Digit Verification	30h	Disabled	114
Transmit Code 39 Check Digit	2Bh	Disabled	114

Standard Default Parameters

Table 18 Standard Default Parameters Table (Continued)

Parameter	Parameter Number	Default	Page Number
Code 39 Full ASCII Conversion	11h	Disabled	115
Buffer Code 39	71h	Disabled	115
Code 93			
Code 93	09h	Disabled	118
Set Length(s) for Code 93	1Ah 1Bh	4 to 55	118
Code 11			
Code 11	0Ah	Disabled	120
Set Lengths for Code 11	1Ch 1Dh	4 to 55	120
Code 11 Check Digit Verification	34h	Disabled	121
Transmit Code 11 Check Digit(s)	2Fh	Disabled	123
Interleaved 2 of 5 (ITF)			
Interleaved 2 of 5 (ITF)	06h	Enabled	123
Set Lengths for I 2 of 5	16h 17h	14	124
I 2 of 5 Check Digit Verification	31h	Disabled	126
Transmit I 2 of 5 Check Digit	2Ch	Disabled	126
Convert I 2 of 5 to EAN 13	52h	Disabled	127
Discrete 2 of 5 (DTF)			
Discrete 2 of 5	05h	Disabled	127
Set Length(s) for D 2 of 5	14h 15h	12	128
Codabar (NW - 7)			
Codabar	07h	Disabled	130
Set Lengths for Codabar	18h 19h	5 to 55	130
CLSI Editing	36h	Disabled	131
NOTIS Editing	37h	Disabled	132
MSI			
MSI	0Bh	Disabled	133
Set Length(s) for MSI	1Eh 1Fh	4 to 55	133
MSI Check Digits	32h	One	134
Transmit MSI Check Digit	2Eh	Disabled	135
MSI Check Digit Algorithm	33h	Mod 10/Mod 10	136

Standard Default Parameters

Table 18 Standard Default Parameters Table (Continued)

Parameter	Parameter Number	Default	Page Number
Chinese 2 of 5			
Chinese 2 of 5	F0h 98h	Disabled	136
Matrix 2 of 5			
Matrix 2 of 5	F1h 6Ah	Disable	137
Matrix 2 of 5 Lengths	F1h 6Bh F1h 6Ch	1 Length - 14	138
Matrix 2 of 5 Redundancy	F1h 6Dh	Disabled	139
Matrix 2 of 5 Check Digit	F1h 6Eh	Disabled	139
Transmit Matrix 2 of 5 Check Digit	F1h 6Fh	Disabled	140
Inverse 1D	F1h 4Ah	Regular	140
Postal Codes			
US Postnet	59h	Disabled	141
US Planet	5Ah	Disabled	141
Transmit US Postal Check Digit	5Fh	Enabled	142
UK Postal	5Bh	Disabled	142
Transmit UK Postal Check Digit	60h	Enabled	143
Japan Postal	F0h 22h	Disabled	143
Australian Postal	F0h 23h	Disabled	144
Netherlands KIX Code	F0h 46h	Disabled	144
USPS 4CB/One Code/Intelligent Mail	F1h 50h	Disabled	145
UPU FICS Postal	F1h 63h	Disabled	145
GS1 DataBar			
GS1 DataBar-14	F0h 52h	Disabled	146
GS1 DataBar Limited	F0h 53h	Disabled	146
GS1 DataBar Expanded	F0h 54h	Disabled	147
Convert GS1 DataBar to UPC/EAN	F0h 8Dh	Disabled	147
Composite			
Composite CC-C	F0h 55h	Disabled	148
Composite CC-A/B	F0h 56h	Disabled	148
Composite TLC-39	F0h 73h	Disabled	149
UPC Composite Mode	F0h 58h	Never Linked	149

Table 18 Standard Default Parameters Table (Continued)

Parameter	Parameter Number	Default	Page Number
Composite Beep Mode	F0h 8Eh	Beep As Each Code Type is Decoded	150
GS1-128 Emulation Mode for UCC/EAN Composite Codes	F0h ABh	Disabled	150
2D Symbolologies			
PDF417	0Fh	Enabled	151
MicroPDF417	E3h	Disabled	151
Code 128 Emulation	7Bh	Disabled	151
Data Matrix	F0h 24h	Enabled	153
Data Matrix Inverse	F1h 4Ch	Regular	153
Maxicode	F0h 26h	Enabled	154
QR Code	F0h 25h	Enabled	154
QR Inverse	F1h 4Bh	Regular	155
MicroQR	F1h 3Dh	Enabled	155
Aztec	F1h 3Eh	Enabled	156
Aztec Inverse	F1h 4Dh	Regular	156
Symbology-Specific Security Levels			
Redundancy Level	4Eh	1	157
Security Level	4Dh	0	158
Intercharacter Gap Size	F0h 7Dh	Normal	159
Macro PDF			
Flush Macro PDF Buffer			161
Abort Macro PDF Entry			161

Programming Reference

Symbol Code Identifiers

Table 19 Symbol Code Characters

Code Character	Code Type
A	UPC-A, UPC-E, UPC-E1, EAN-8, EAN-13
B	Code 39, Code 32
C	Codabar
D	Code 128
E	Code 93
F	Interleaved 2 of 5
G	Discrete 2 of 5, or Discrete 2 of 5 IATA
H	Code 11
J	MSI
K	GS1-128
L	Bookland EAN
M	Trioptic Code 39
N	Coupon Code
R	GS1 DataBar Family
T	UCC Composite, TLC 39
X	PDF417, Macro PDF417, Micro PDF417
z	Aztec, Aztec Rune
P00	Data Matrix
P01	QR Code, MicroQR
P02	Maxicode
P03	US Postnet

Table 19 Symbol Code Characters (Continued)

Code Character	Code Type
P04	US Planet
P05	Japan Postal
P06	UK Postal
P08	Netherlands KIX Code
P09	Australian Postal
P0A	USPS 4CB/One Code/Intelligent Mail
P0B	UPU FICS Postal

AIM Code Identifiers

Each AIM Code Identifier contains the three-character string **jcm** where:

- j = Flag Character (ASCII 93)
- c = Code Character (see [Table 20](#))
- m = Modifier Character (see [Table 21](#))

Table 20 Aim Code Characters

Code Character	Code Type
A	Code 39, Code 39 Full ASCII, Code 32
C	Code 128, Coupon (Code 128 portion)
d	Data Matrix
E	UPC/EAN, Coupon (UPC portion)
e	GS1 DataBar Family
F	Codabar
G	Code 93
H	Code 11
I	Interleaved 2 of 5
L	PDF417, Macro PDF417, Micro PDF417
M	MSI
Q	QR Code, MicroQR
S	Discrete 2 of 5, IATA 2 of 5
U	Maxicode

Table 20 Aim Code Characters (Continued)

Code Character	Code Type
z	Aztec, Aztec Rune
X	Bookland EAN, Trioptic Code 39, US Postnet, US Planet, UK Postal, Japan Postal, Australian Postal, Netherlands KIX Code, USPS 4CB/One Code/Intelligent Mail, UPU FICS Postal

The modifier character is the sum of the applicable option values based on [Table 21](#).

Table 21 Modifier Characters

Code Type	Option Value	Option
Code 39	0	No check character or Full ASCII processing.
	1	Reader has checked one check character.
	3	Reader has checked and stripped check character.
	4	Reader has performed Full ASCII character conversion.
	5	Reader has performed Full ASCII character conversion and checked one check character.
	7	Reader has performed Full ASCII character conversion and checked and stripped check character.
	Example: A Full ASCII bar code with check character W, A+I+MI+DW , is transmitted as J A7AIMID where 7 = (3+4).	
Trioptic Code 39	0	No option specified at this time. Always transmit 0.
	Example: A Trioptic bar code 412356 is transmitted as J X0412356	
Code 128	0	Standard data packet, no Function code 1 in first symbol position.
	1	Function code 1 in first symbol character position.
	2	Function code 1 in second symbol character position.
	Example: A Code (EAN) 128 bar code with Function 1 character ^{FNC1} in the first position, AIMID is transmitted as J C1AIMID	
I 2 of 5	0	No check digit processing.
	1	Reader has validated check digit.
	3	Reader has validated and stripped check digit.
	Example: An I 2 of 5 bar code without check digit, 4123, is transmitted as J I04123	
Codabar	0	No check digit processing.
	1	Reader has checked check digit.
	3	Reader has stripped check digit before transmission.
	Example: A Codabar bar code without check digit, 4123, is transmitted as J F04123	
Code 93	0	No options specified at this time. Always transmit 0.
	Example: A Code 93 bar code 012345678905 is transmitted as J G0012345678905	

Table 21 Modifier Characters (Continued)

Code Type	Option Value	Option
MSI	0	Check digits are sent.
	1	No check digit is sent.
	Example: An MSI bar code 4123, with a single check digit checked, is transmitted as JM14123	
D 2 of 5	0	No options specified at this time. Always transmit 0.
	Example: A D 2 of 5 bar code 4123, is transmitted as JS04123	
UPC/EAN	0	Standard data packet in full EAN format, i.e. 13 digits for UPC-A, UPC-E, and EAN-13 (not including supplemental data).
	1	Two digit supplemental data only.
	2	Five digit supplemental data only.
	3	Combined data packet comprising 13 digits from EAN-13, UPC-A or UPC-E symbol and 2 or 5 digits from supplemental symbol.
	4	EAN-8 data packet.
	Example: A UPC-A bar code 012345678905 is transmitted as JE00012345678905	
Bookland EAN	0	No options specified at this time. Always transmit 0.
	Example: A Bookland EAN bar code 123456789X is transmitted as JX0123456789X	
Code 11	0	Single check digit
	1	Two check digits
	3	Check characters validated but not transmitted.
GS1 DataBar Family		No option specified at this time. Always transmit 0. GS1 DataBar-14 and GS1 DataBar Limited transmit with an Application Identifier "01". Note: In GS1-128 emulation mode, GS1 DataBar is transmitted using Code 128 rules (i.e., JC1).
	Example: A GS1 DataBar-14 bar code 100123456788902 is transmitted as Je001100123456788902 .	

Table 21 Modifier Characters (Continued)

Code Type	Option Value	Option
EAN.UCC Composites (GS1 DataBar, GS1-128, 2D portion of UPC composite)		Native mode transmission. Note: UPC portion of composite is transmitted using UPC rules.
	0	Standard data packet.
	1	Data packet containing the data following an encoded symbol separator character.
	2	Data packet containing the data following an escape mechanism character. The data packet does not support the ECI protocol.
	3	Data packet containing the data following an escape mechanism character. The data packet supports the ECI protocol.
		GS1-128 emulation Note: UPC portion of composite is transmitted using UPC rules.
	1	Data packet is a GS1-128 symbol (i.e., data is preceded with]JC1).
PDF417, Micro PDF417	0	Reader set to conform to protocol defined in 1994 PDF417 symbology specifications. Note: When this option is transmitted, the receiver cannot reliably determine whether ECIs have been invoked or whether data byte 92 _{DEC} has been doubled in transmission.
	1	Reader set to follow the ECI protocol (Extended Channel Interpretation). All data characters 92 _{DEC} are doubled.
	2	Reader set for Basic Channel operation (no escape character transmission protocol). Data characters 92 _{DEC} are not doubled. Note: When decoders are set to this mode, unbuffered Macro symbols and symbols requiring the decoder to convey ECI escape sequences cannot be transmitted.
	3	The bar code contains a GS1-128 symbol, and the first codeword is 903-907, 912, 914, 915.
	4	The bar code contains a GS1-128 symbol, and the first codeword is in the range 908-909.
	5	The bar code contains a GS1-128 symbol, and the first codeword is in the range 910-911.
		Example: A PDF417 bar code ABCD, with no transmission protocol enabled, is transmitted as]L2ABCD.
Data Matrix	0	ECC 000-140, not supported.
	1	ECC 200.
	2	ECC 200, FNC1 in first or fifth position.
	3	ECC 200, FNC1 in second or sixth position.
	4	ECC 200, ECI protocol implemented.
	5	ECC 200, FNC1 in first or fifth position, ECI protocol implemented.
	6	ECC 200, FNC1 in second or sixth position, ECI protocol implemented.

Table 21 Modifier Characters (Continued)

Code Type	Option Value	Option
MaxiCode	0	Symbol in Mode 4 or 5.
	1	Symbol in Mode 2 or 3.
	2	Symbol in Mode 4 or 5, ECI protocol implemented.
	3	Symbol in Mode 2 or 3, ECI protocol implemented in secondary message.
QR Code	0	Model 1 symbol.
	1	Model 2 / MicroQR symbol, ECI protocol not implemented.
	2	Model 2 symbol, ECI protocol implemented.
	3	Model 2 symbol, ECI protocol not implemented, FNC1 implied in first position.
	4	Model 2 symbol, ECI protocol implemented, FNC1 implied in first position.
	5	Model 2 symbol, ECI protocol not implemented, FNC1 implied in second position.
	6	Model 2 symbol, ECI protocol implemented, FNC1 implied in second position.
Aztec	0	Aztec symbol.
	C	Aztec Rune symbol.

Sample Bar Codes

Code 39



UPC/EAN

UPC-A, 100%



EAN-13, 100%



Code 128



Interleaved 2 of 5



GS1 DataBar-14

✓ **NOTE:** DataBar-14 must be enabled to read the bar code below.



PDF417



Data Matrix



Maxicode

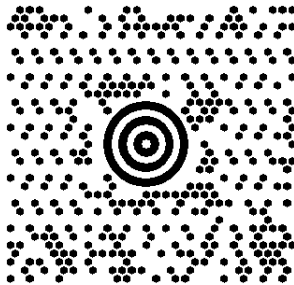

QR Code



US Postnet



UK Postal



Numeric Bar Codes

Numeric Bar Codes

For parameters requiring specific numeric values, scan the appropriately numbered bar code(s).



Numeric Bar Codes (continued)

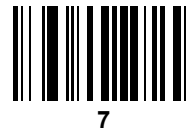

Cancel

To correct an error or change a selection, scan the bar code below.



Glossary

A

Aperture. The opening in an optical system defined by a lens or baffle that establishes the field of view.

API. An interface by means of which one software component communicates with or controls another. Usually used to refer to services provided by one software component to another, usually via software interrupts or function calls

Application Programming Interface. See **API**.

ASCII. American Standard Code for Information Interchange. A 7 bit-plus-parity code representing 128 letters, numerals, punctuation marks and control characters. It is a standard data transmission code in the U.S.

Autodiscrimination. The ability of an interface controller to determine the code type of a scanned bar code. After this determination is made, the information content is decoded.

B

Bar. The dark element in a printed bar code symbol.

Bar Code. A pattern of variable-width bars and spaces which represents numeric or alphanumeric data in machine-readable form. The general format of a bar code symbol consists of a leading margin, start character, data or message character, check character (if any), stop character, and trailing margin. Within this framework, each recognizable symbology uses its own unique format. See **Symbology**.

Bar Code Density. The number of characters represented per unit of measurement (e.g., characters per inch).

Bar Height. The dimension of a bar measured perpendicular to the bar width.

Bar Width. Thickness of a bar measured from the edge closest to the symbol start character to the trailing edge of the same bar.

BIOS. Basic Input Output System. A collection of ROM-based code with a standard API used to interface with standard PC hardware.

Bit. Binary digit. One bit is the basic unit of binary information. Generally, eight consecutive bits compose one byte of data. The pattern of 0 and 1 values within the byte determines its meaning.

Bits per Second (bps). Bits transmitted or received.

Boot or Boot-up. The process a computer goes through when it starts. During boot-up, the computer can run self-diagnostic tests and configure hardware and software.

BOOTP. A protocol for remote booting of diskless devices. Assigns an IP address to a machine and may specify a boot file. The client sends a bootp request as a broadcast to the bootp server port (67) and the bootp server responds using the bootp client port (68). The bootp server must have a table of all devices, associated MAC addresses and IP addresses.

bps. See **Bits Per Second**.

Byte. On an addressable boundary, eight adjacent binary digits (0 and 1) combined in a pattern to represent a specific character or numeric value. Bits are numbered from the right, 0 through 7, with bit 0 the low-order bit. One byte in memory is used to store one ASCII character.

C

CDRH. Center for Devices and Radiological Health. A federal agency responsible for regulating laser product safety. This agency specifies various laser operation classes based on power output during operation.

CDRH Class 1. This is the lowest power CDRH laser classification. This class is considered intrinsically safe, even if all laser output were directed into the eye's pupil. There are no special operating procedures for this class.

CDRH Class 2. No additional software mechanisms are needed to conform to this limit. Laser operation in this class poses no danger for unintentional direct human exposure.

Character. A pattern of bars and spaces which either directly represents data or indicates a control function, such as a number, letter, punctuation mark, or communications control contained in a message.

Character Set. Those characters available for encoding in a particular bar code symbology.

Check Digit. A digit used to verify a correct symbol decode. The scanner inserts the decoded data into an arithmetic formula and checks that the resulting number matches the encoded check digit. Check digits are required for UPC but are optional for other symbologies. Using check digits decreases the chance of substitution errors when a symbol is decoded.

Codabar. A discrete self-checking code with a character set consisting of digits 0 to 9 and six additional characters: (- \$: / , +).

Code 128. A high density symbology which allows the controller to encode all 128 ASCII characters without adding extra symbol elements.

Code 3 of 9 (Code 39). A versatile and widely used alphanumeric bar code symbology with a set of 43 character types, including all uppercase letters, numerals from 0 to 9 and 7 special characters (- . / + % \$ and space). The code name is derived from the fact that 3 of 9 elements representing a character are wide, while the remaining 6 are narrow.

Code 93. An industrial symbology compatible with Code 39 but offering a full character ASCII set and a higher coding density than Code 39.

Code Length. Number of data characters in a bar code between the start and stop characters, not including those characters.

Cold Boot. A cold boot restarts the mobile computer and erases all user stored records and entries.

COM port. Communication port; ports are identified by number, e.g., COM1, COM2.

Continuous Code. A bar code or symbol in which all spaces within the symbol are parts of characters. There are no intercharacter gaps in a continuous code. The absence of gaps allows for greater information density.

Cradle. A cradle is used for charging the terminal battery and for communicating with a host computer, and provides a storage place for the terminal when not in use.

D

Dead Zone. An area within a scanner's field of view, in which specular reflection may prevent a successful decode.

Decode. To recognize a bar code symbology (e.g., UPC/EAN) and then analyze the content of the specific bar code scanned.

Decode Algorithm. A decoding scheme that converts pulse widths into data representation of the letters or numbers encoded within a bar code symbol.

Decryption. Decryption is the decoding and unscrambling of received encrypted data. Also see, **Encryption** and **Key**.

Depth of Field. The range between minimum and maximum distances at which a scanner can read a symbol with a certain minimum element width.

Discrete 2 of 5. A binary bar code symbology representing each character by a group of five bars, two of which are wide. The location of wide bars in the group determines which character is encoded; spaces are insignificant. Only numeric characters (0 to 9) and START/STOP characters may be encoded.

Discrete Code. A bar code or symbol in which the spaces between characters (intercharacter gaps) are not part of the code.

DRAM. Dynamic random access memory.

E

EAN. European Article Number. This European/International version of the UPC provides its own coding format and symbology standards. Element dimensions are specified metrically. EAN is used primarily in retail.

Element. Generic term for a bar or space.

Encoded Area. Total linear dimension occupied by all characters of a code pattern, including start/stop characters and data.

ENQ (RS-232). ENQ software handshaking is also supported for the data sent to the host.

ESD. Electro-Static Discharge

F

Flash Disk. An additional megabyte of non-volatile memory for storing application and configuration files.

Flash Memory. Flash memory is responsible for storing the system firmware and is non-volatile. If the system power is interrupted the data is not be lost.

FTP. See **File Transfer Protocol**.

H

Hard Reset. See **Cold Boot**.

Host Computer. A computer that serves other terminals in a network, providing such services as computation, database access, supervisory programs and network control.

Hz. Hertz; A unit of frequency equal to one cycle per second.

I

IDE. Intelligent drive electronics. Refers to the solid-state hard drive type.

IEC. International Electrotechnical Commission. This international agency regulates laser safety by specifying various laser operation classes based on power output during operation.

IEC (825) Class 1. This is the lowest power IEC laser classification. Conformity is ensured through a software restriction of 120 seconds of laser operation within any 1000 second window and an automatic laser shutdown if the scanner's oscillating mirror fails.

IEEE Address. See **MAC Address**.

Input/Output Ports. I/O ports are primarily dedicated to passing information into or out of the terminal's memory. Series 9000 mobile computers include Serial and USB ports.

Intercharacter Gap. The space between two adjacent bar code characters in a discrete code.

Interleaved 2 of 5. A binary bar code symbology representing character pairs in groups of five bars and five interleaved spaces. Interleaving provides for greater information density. The location of wide elements (bar/spaces) within each group determines which characters are encoded. This continuous code type uses no intercharacter spaces. Only numeric (0 to 9) and START/STOP characters may be encoded.

Interleaved Bar Code. A bar code in which characters are paired together, using bars to represent the first character and the intervening spaces to represent the second.

Interleaved 2 of 5. A binary bar code symbology representing character pairs in groups of five bars and five interleaved spaces. Interleaving provides for greater information density. The location of wide elements (bar/spaces) within each group determines which characters are encoded. This continuous code type uses no intercharacter spaces. Only numeric (0 to 9) and START/STOP characters may be encoded.

I/O Ports. interface The connection between two devices, defined by common physical characteristics, signal characteristics, and signal meanings. Types of interfaces include RS-232 and PCMCIA.

IOCTL. Input/Output Control.

IP Address. (Internet Protocol address) The address of a computer attached to an IP network. Every client and server station must have a unique IP address. A 32-bit address used by a computer on a IP network. Client workstations have either a permanent address or one that is dynamically assigned to them each session. IP addresses are written as four sets of numbers separated by periods; for example, 204.171.64.2.

IPX/SPX. Internet Package Exchange/Sequential Packet Exchange. A communications protocol for Novell. IPX is Novell's Layer 3 protocol, similar to XNS and IP, and used in NetWare networks. SPX is Novell's version of the Xerox SPP protocol.

IS-95. Interim Standard 95. The EIA/TIA standard that governs the operation of CDMA cellular service. Versions include IS-95A and IS-95B. See CDMA.

K

Key. A key is the specific code used by the algorithm to encrypt or decrypt the data. Also see, **Encryption** and **Decrypting**.

L

LASER. Light Amplification by Stimulated Emission of Radiation. The laser is an intense light source. Light from a laser is all the same frequency, unlike the output of an incandescent bulb. Laser light is typically coherent and has a high energy density.

Laser Diode. A gallium-arsenide semiconductor type of laser connected to a power source to generate a laser beam. This laser type is a compact source of coherent light.

Laser Scanner. A type of bar code reader that uses a beam of laser light.

LCD. See **Liquid Crystal Display**.

LED Indicator. A semiconductor diode (LED - Light Emitting Diode) used as an indicator, often in digital displays. The semiconductor uses applied voltage to produce light of a certain frequency determined by the semiconductor's particular chemical composition.

Light Emitting Diode. See **LED**.

Liquid Crystal Display (LCD). A display that uses liquid crystal sealed between two glass plates. The crystals are excited by precise electrical charges, causing them to reflect light outside according to their bias. They use little electricity and react relatively quickly. They require external light to reflect their information to the user.

M

MIL. 1 mil = 1 thousandth of an inch.

Misread (Misdecode). A condition which occurs when the data output of a reader or interface controller does not agree with the data encoded within a bar code symbol.

N

Nominal. The exact (or ideal) intended value for a specified parameter. Tolerances are specified as positive and negative deviations from this value.

Nominal Size. Standard size for a bar code symbol. Most UPC/EAN codes are used over a range of magnifications (e.g., from 0.80 to 2.00 of nominal).

NVM. Non-Volatile Memory.

O

ODI. See **Open Data-Link Interface**.

Open Data-Link Interface (ODI). Novell's driver specification for an interface between network hardware and higher-level protocols. It supports multiple protocols on a single NIC (Network Interface Controller). It is capable of understanding and translating any network information or request sent by any other ODI-compatible protocol into something a NetWare client can understand and process.

Open System Authentication. Open System authentication is a null authentication algorithm.

P

PAN . Personal area network. Using Bluetooth wireless technology, PANs enable devices to communicate wirelessly. Generally, a wireless PAN consists of a dynamic group of less than 255 devices that communicate within about a 33-foot range. Only devices within this limited area typically participate in the network.

Parameter. A variable that can have different values assigned to it.

PC Card. A plug-in expansion card for laptop computers and other devices, also called a PCMCIA card. PC Cards are 85.6mm long x 54 mm wide, and have a 68 pin connector. There are several different kinds:

- Type I; 3.3 mm high; use - RAM or Flash RAM
- Type II; 5 mm high; use - modems, LAN adaptors
- Type III; 10.5 mm high; use - Hard Disks

PCMCIA. Personal Computer Memory Card Interface Association. See **PC Card**.

Percent Decode. The average probability that a single scan of a bar code would result in a successful decode. In a well-designed bar code scanning system, that probability should approach near 100%.

PING. (Packet Internet Groper) An Internet utility used to determine whether a particular IP address is online. It is used to test and debug a network by sending out a packet and waiting for a response.

Print Contrast Signal (PCS). Measurement of the contrast (brightness difference) between the bars and spaces of a symbol. A minimum PCS value is needed for a bar code symbol to be scannable. $PCS = (RL - RD) / RL$, where RL is the reflectance factor of the background and RD the reflectance factor of the dark bars.

Programming Mode. The state in which a scanner is configured for parameter values. See **Scanning Mode**.

Q

Quiet Zone. A clear space, containing no dark marks, which precedes the start character of a bar code symbol and follows the stop character.

QWERTY. A standard keyboard commonly used on North American and some European PC keyboards. "QWERTY" refers to the arrangement of keys on the left side of the third row of keys.

R

RAM. Random Access Memory. Data in RAM can be accessed in random order, and quickly written and read.

Reflectance. Amount of light returned from an illuminated surface.

Resolution. The narrowest element dimension which is distinguished by a particular reading device or printed with a particular device or method.

RF. Radio Frequency.

ROM. Read-Only Memory. Data stored in ROM cannot be changed or removed.

Router. A device that connects networks and supports the required protocols for packet filtering. Routers are typically used to extend the range of cabling and to organize the topology of a network into subnets. See **Subnet**.

RS-232. An Electronic Industries Association (EIA) standard that defines the connector, connector pins, and signals used to transfer data serially from one device to another.

S

Scan Area. Area intended to contain a symbol.

Scanner. An electronic device used to scan bar code symbols and produce a digitized pattern that corresponds to the bars and spaces of the symbol. Its three main components are: 1) Light source (laser or photoelectric cell) - illuminates a bar code;; 2) Photodetector - registers the difference in reflected light (more light reflected from spaces); 3) Signal conditioning circuit - transforms optical detector output into a digitized bar pattern.

Scanning Mode. The scanner is energized, programmed and ready to read a bar code.

Scanning Sequence. A method of programming or configuring parameters for a bar code reading system by scanning bar code menus.

SDK. Software Development Kit

Self-Checking Code. A symbology that uses a checking algorithm to detect encoding errors within the characters of a bar code symbol.

Shared Key. Shared Key authentication is an algorithm where both the AP and the MU share an authentication key.

SHIP. Symbol Host Interface Program.

SID. System Identification code. An identifier issued by the FCC for each market. It is also broadcast by the cellular carriers to allow cellular devices to distinguish between the home and roaming service.

Soft Reset. See **Warm Boot.**

Space. The lighter element of a bar code formed by the background between bars.

Specular Reflection. The mirror-like direct reflection of light from a surface, which can cause difficulty decoding a bar code.

Standard Trigger Mode. The Imager uses this mode when lifted off the counter or removed from the wall mount. In this mode, aim the Imager at a bar code and pull the trigger to decode.

Start/Stop Character. A pattern of bars and spaces that provides the scanner with start and stop reading instructions and scanning direction. The start and stop characters are normally to the left and right margins of a horizontal code.

STEP. Symbol Terminal Enabler Program.

Subnet. A subset of nodes on a network that are serviced by the same router. See **Router.**

Subnet Mask. A 32-bit number used to separate the network and host sections of an IP address. A custom subnet mask subdivides an IP network into smaller subsections. The mask is a binary pattern that is matched up with the IP address to turn part of the host ID address field into a field for subnets. Default is often 255.255.255.0.

Substrate. A foundation material on which a substance or image is placed.

SVTP. Symbol Virtual Terminal Program.

Symbol. A scannable unit that encodes data within the conventions of a certain symbology, usually including start/stop characters, quiet zones, data characters and check characters.

Symbol Aspect Ratio. The ratio of symbol height to symbol width.

Symbol Height. The distance between the outside edges of the quiet zones of the first row and the last row.

Symbol Length. Length of symbol measured from the beginning of the quiet zone (margin) adjacent to the start character to the end of the quiet zone (margin) adjacent to a stop character.

Symbology. The structural rules and conventions for representing data within a particular bar code type (e.g. UPC/EAN, Code 39, PDF417, etc.).

T

TCP/IP. (Transmission Control Protocol/Internet Protocol) A communications protocol used to internetwork dissimilar systems. This standard is the protocol of the Internet and has become the global standard for communications. TCP provides transport functions, which ensures that the total amount of bytes sent is received correctly at the other end. UDP is an alternate transport that does not guarantee delivery. It is widely used for real-time voice and video transmissions where erroneous packets are not retransmitted. IP provides the routing mechanism. TCP/IP is a routable protocol, which means that all messages contain not only the address of the destination station, but the address of a destination network. This allows TCP/IP messages to be sent to multiple networks within an organization or around the world, hence its use in the worldwide Internet. Every client and server in a TCP/IP network requires an IP address, which is either permanently assigned or dynamically assigned at startup.

Telnet. A terminal emulation protocol commonly used on the Internet and TCP/IP-based networks. It allows a user at a terminal or computer to log onto a remote device and run a program.

Terminal Emulation. A “terminal emulation” emulates a character-based mainframe session on a remote non-mainframe terminal, including all display features, commands and function keys. The VC5000 Series supports Terminal Emulations in 3270, 5250 and VT220.

Terminate and Stay Resident (TSR). A program under DOS that ends its foreground execution to remain resident in memory to service hardware/software interrupts, providing background operation. It remains in memory and may provide services on behalf of other DOS programs.

TFTP. (Trivial File Transfer Protocol) A version of the TCP/IP FTP (File Transfer Protocol) protocol that has no directory or password capability. It is the protocol used for upgrading firmware, downloading software and remote booting of diskless devices.

Tolerance. Allowable deviation from the nominal bar or space width.

Transmission Control Protocol/Internet Protocol. See **TCP/IP**.

Trivial File Transfer Protocol. See **TFTP**.

TSR. See **Terminate and Stay Resident**.

U

UDP. User Datagram Protocol. A protocol within the IP protocol suite that is used in place of TCP when a reliable delivery is not required. For example, UDP is used for real-time audio and video traffic where lost packets are

simply ignored, because there is no time to retransmit. If UDP is used and a reliable delivery is required, packet sequence checking and error notification must be written into the applications.

UPC. Universal Product Code. A relatively complex numeric symbology. Each character consists of two bars and two spaces, each of which is any of four widths. The standard symbology for retail food packages in the United States.

V

Visible Laser Diode (VLD). A solid state device which produces visible laser light.

W

Warm Boot. A warm boot restarts the mobile computer by closing all running programs. All data that is not saved to flash memory is lost.

Index

Numerics

123Scan	220
requirements	221
2D bar codes	
aztec	156
aztec inverse	156
code 128 emulation	151
data matrix	153
data matrix inverse	153
maxicode	154
microPDF417	151
microQR	155
PDF417	151
QR code	154
QR inverse	155

A

Acceptable Aiming Options	30
ADF	221
advanced data formatting	221
auto-triggering mode	29

B

bar codes	
Australian postal	144
aztec	156
aztec inverse	156
batch mode	216, 218
beep after good decode	69
beeper tone	70
beeper volume	71
bookland EAN	92
bookland ISBN	104
buffering	115, 116
cancel	242
Chinese 2 of 5	136
codabar	130
codabar CLSI editing	131
codabar lengths	130

codabar NOTIS editing	132
code 11	120
code 11 lengths	120
code 128	106
code 128 emulation	151
code 128 lengths	106
code 39	111
transmit buffer	117
code 39 check digit verification	114
code 39 full ASCII	115
code 39 lengths	113
code 39 transmit check digit	114
code 93	118
code 93 lengths	118
composite CC-A/B	148
composite CC-C	148
composite TLC-39	149
convert GS1 databar to UPC/EAN	147
convert UPC-E to UPC-A	101
convert UPC-E1 to UPC-A	102
data matrix	153
data matrix inverse	153
discrete 2 of 5	127
lengths	129
EAN zero extend	103
EAN-13/JAN-13	92
EAN-8/JAN-8	91
flush macro buffer/abort macro PDF entry	161
FN1 substitution values	82
fuzzy 1D processing	74
GS1 catabar limited	146
GS1 DataBar	145
GS1 databar expanded	147
GS1 databar-14	146
GS1-128	107
host triggering	73
I 2 of 5 check digit verification	126
I 2 of 5 convert to EAN-13	127
I 2 of 5 transmit check digit	126
illumination	75
interleaved 2 of 5	123
convert to EAN-13	127

lengths	124
inverse 1D	140
ISBT 128	108
ISBT concatenation	109, 110
ISBT concatenation redundancy	110
ISSN EAN	105
Japan postal	143
matrix 2 of 5	137
matrix 2 of 5 check digit	139
matrix 2 of 5 lengths	138
matrix 2 of 5 redundancy	139
maxicode	154
microPDF417	151
microQR	155
MSI	133
MSI check digit algorithm	136
MSI check digits	134
MSI lengths	133
MSI transmit check digit	135
Netherlands KIX code	144
numeric bar codes	242
parameter scanning	69
PDF417	151
picklist modes	73
postal	141
prefix/suffix values	79
QR code	154
QR inverse	155
samples	237
scan data options	80
set defaults	68
supplementals	93
symbolologies	
default table	85
transmit code ID character	78
transmit matrix 2 of 5 check digit	140
transmit no read message	83
transmit UK postal check digit	143
transmit US postal check digit	142
UCC coupon extended code	105
UK postal	142
UPC composite mode	149
UPC/EAN	
coupon code	105
supp redundancy	96, 97
UPC/EAN/JAN	
supplemental AIM ID format	97
supplemental redundancy	96
UPC-A	90
UPC-A preamble	98
UPC-A/E/E1 check digit	97, 98
UPC-E	90
UPC-E preamble	99
UPC-E1	90
UPU FICS postal	145
US planet	141
US postnet	141
USPS 4CB/One Code/Intelligent Mail	145
battery	
charging	20, 36
Battery Age Test	36
Battery Release	20
beep sequences	24
Bluetooth	
encryption	215
secure simple pairing IO capability	215
bright center dot	29
bullets	13
C	
change trigger configuration	30
Charge Status LED	37
Charger	32
charging batteries	20, 36
Charging Imager battery	35
Clean Boot	31
codabar bar codes	
CLSI editing	131
codabar	130
lengths	130
NOTIS editing	132
code 11 bar codes	
code 11	120
lengths	120
code 128 bar codes	
code 128	106
GS1-128	107
ISBT 128	108
ISBT concatenation	109, 110
ISBT concatenation redundancy	110
lengths	106
code 128 emulation bar codes	151
code 39 bar codes	
buffering	115, 116
check digit verification	114
code 39	111
full ASCII	115
lengths	113
transmit check digit	114
code 93 bar codes	
code 93	118
lengths	118
code ID character	78
code identifiers	
AIM code IDs	232
modifier characters	233
Symbol	231
Cold Boot	31
composite bar codes	

composite CC-A/B	148
composite CC-C	148
composite TLC-39	149
UPC composite mode	149
conventions	
notational	13
Corded Adapter	21
Cradle charger	34
Cradle Installation	34
Cradle wall mount	34
Cross Hair Lines	29

D

data matrix bar codes	153
default parameters	
standard default table	226
sympologies	85
user preferences	67
discrete 2 of 5 bar codes	
discrete 2 of 5	127

E

encryption	215
exposure options	
illumination	75

F

Finger Strap	23
--------------	----

G

getting started	20, 36
GS1 DataBar	145
GS1 databar	
convert GS1 databar to UPC/EAN	147

I

illumination	75
index and middle fingers	23
information, service	14
interleaved 2 of 5 bar codes	
check digit verification	126
convert to EAN-13	127
transmit check digit	126

M

macro PDF	161
flush buffer/abort PDF entry	161
Manual Triggering	28
matrix 2 of 5 bar codes	137

check digit	139
lengths	138
redundancy	139
transmit check digit	140
maxicode bar codes	154
microPDF417 bar codes	151
MSI bar codes	
check digit algorithm	136
check digits	134
lengths	133
MSI	133
transmit check digit	135

N

notational conventions	13
------------------------	----

P

parameters	
batch mode	216, 218
radio communication	
batch mode	216, 218
parts of the mobile computer	15
PDF417 bar codes	151
postal codes	141
Australian postal	144
Japan postal	143
Netherlands KIX code	144
transmit UK postal check digit	143
transmit US postal check digit	142
UK postal	142
UPU FICS postal	145
US planet	141
US postnet	141
USPS 4CB/One Code/Intelligent Mail	145

Q

QR code bar codes	154
-------------------	-----

R

reestablish Bluetooth connection	27
Remove Bluetooth connection	27
Replaceable Parts	45
Resetting	31

S

sample bar codes	237
scanning	
errors	67, 85
sequence example	66, 84
secure simple pairing IO capability	215

service information	14
SMDK for C	14
software tools	
123Scan	220
ADF	221
SSI Simple Serial Interface	162
standard default parameters	226
Standby	25
Strap Buckle	19
Symbol Mobility Developer Kit for C	14
Symbol Scan Orientation	29
symbology default parameters	85

T

trigger	
programming via host	73
Trigger Position	19
Trigger Swivel Assembly	19

U

unpacking	16
unpairing barcode	27
UPC/EAN bar codes	
bookland EAN	92
bookland ISBN	104
check digit	97, 98
convert UPC-E to UPC-A	101
convert UPC-E1 to UPC-A	102
EAN zero extend	103
EAN-13/JAN-13	92
EAN-8/JAN-8	91
ISSN EAN	105
supplementals	93
UCC coupon extended code	105
UPC-A	90
UPC-A preamble	98
UPC-E	90
UPC-E preamble	99
UPC-E1	90
user preferences bar codes	
batch mode	216, 218
user preferences parameters	67

W

Warm Boot	31
-----------------	----

