

S P T 1 8 0 0 S e r i e s



**symbol**<sup>®</sup>

© 2001 SYMBOL TECHNOLOGIES, INC. All rights reserved.

Symbol reserves the right to make changes to any product to improve reliability, function, or design.

Symbol does not assume any product liability arising out of, or in connection with, the application or use of any product, circuit, or application described herein.

No license is granted, either expressly or by implication, estoppel, or otherwise under any patent right or patent, covering or relating to any combination, system, apparatus, machine, material, method, or process in which Symbol products might be used. An implied license only exists for equipment, circuits, and subsystems contained in Symbol products.

Symbol and the Symbol logo are registered trademarks of Symbol Technologies, Inc. Other product names mentioned in this manual may be trademarks or registered trademarks of their respective companies and are hereby acknowledged.

Symbol Technologies, Inc.  
One Symbol Plaza  
Holtsville, N.Y. 11742-1300  
<http://www.symbol.com>

#### Patents

This product is covered by one or more of the following U.S. and foreign Patents:

U.S. Patent No. 4,496,831; 4,593,186; 4,603,262; 4,607,156; 4,652,750; 4,673,805;  
4,736,095; 4,758,717; 4,760,248; 4,806,742; 4,816,660; 4,845,350; 4,896,026; 4,897,532;  
4,923,281; 4,933,538; 4,992,717; 5,015,833; 5,017,765; 5,021,641; 5,029,183; 5,047,617;  
5,103,461; 5,113,445; 5,130,520; 5,140,144; 5,142,550; 5,149,950; 5,157,687; 5,168,148;  
5,168,149; 5,180,904; 5,216,232; 5,229,591; 5,230,088; 5,235,167; 5,243,655; 5,247,162;  
5,250,791; 5,250,792; 5,260,553; 5,262,627; 5,262,628; 5,266,787; 5,278,398; 5,280,162;  
5,280,163; 5,280,164; 5,280,498; 5,304,786; 5,304,788; 5,306,900; 5,321,246; 5,324,924;  
5,337,361; 5,367,151; 5,373,148; 5,378,882; 5,396,053; 5,396,055; 5,399,846; 5,408,081;  
5,410,139; 5,410,140; 5,412,198; 5,418,812; 5,420,411; 5,436,440; 5,444,231; 5,449,891;  
5,449,893; 5,468,949; 5,471,042; 5,478,998; 5,479,000; 5,479,002; 5,479,441; 5,504,322;  
5,519,577; 5,528,621; 5,532,469; 5,543,610; 5,545,889; 5,552,592; 5,557,093; 5,578,810;  
5,581,070; 5,589,679; 5,589,680; 5,608,202; 5,612,531; 5,619,028; 5,627,359; 5,637,852;  
5,664,229; 5,668,803; 5,675,139; 5,693,929; 5,698,835; 5,705,800; 5,714,746; 5,723,851;  
5,734,152; 5,734,153; 5,742,043; 5,745,794; 5,754,587; 5,762,516; 5,763,863; 5,767,500;  
5,789,728; 5,789,731; 5,808,287; 5,811,785; 5,811,787; 5,815,811; 5,821,519; 5,821,520;  
5,823,812; 5,828,050; 5,848,064; 5,850,078; 5,861,615; 5,874,720; 5,875,415; 5,900,617;  
5,902,989; 5,907,146; 5,912,450; 5,914,478; 5,917,173; 5,920,059; 5,923,025; 5,929,420;  
5,945,658; 5,945,659; 5,946,194; 5,959,285; 6,002,918; 6,021,947; 6,031,830; 6,036,098;  
6,047,892; 6,050,491; 6,053,413; 6,056,200; 6,065,678; 6,067,297; 6,068,190; 6,082,621;  
6,084,528; 6,088,482; 6,092,725; 6,101,483; 6,102,293; 6,104,620; 6,114,712; 6,115,678;  
6,119,944; 6,123,265; 6,131,814; 6,138,180; 6,142,379; 6,172,478; 6,176,428; 6,178,426;  
6,186,400; 6,188,681; 6,209,788; 6,216,951; 6,220,514; 6,243,447; 6,244,513; 6,247,647;  
6,308,061; 6,250,551; 6,295,031; D305,885; D341,584; D344,501; D359,483; D362,453;  
D363,700; D363,918; D370,478; D383,124; D391,250; D405,077; D406,581; D414,171;  
D414,172; D418,500; D419,548; D423,468; D424,035; D430,158; D430,159; D431,562;  
D436,104.

Invention No. 55,358; 62,539; 69,060; 69,187 (Taiwan); No. 1,601,796; 1,907,875;  
1,955,269 (Japan); European Patent 367,299; 414,281; 367,300; 367,298; UK 2,072,832;  
France 81/03938; Italy 1,138,713.

rev. 11/01

## Introduction

Congratulations on your purchase of Symbol Technologies' SPT 1800 Series Terminal! The unique combination of capabilities offered by this product makes it superior for use in a wide range of applications:

- Personal Information Management software
- RF communication via Symbol's Spectrum24® wireless network (SPT 184X) or wide area network (SPT 183X)
- Pocket size
- Printing support
- 1-D and 2-D scanning capability.

## About This Guide

This guide covers the procedures for the setup and use of the terminal. Specific topics covered include:

- *Parts of the SPT 1800 on page 2*
- *Installing the SIM Card (SPT 1834 Only) on page 5*
- *Installing the Battery on page 6*
- *Starting the SPT 1800 on page 8*
- *Using the SPT 1800 on page 9*
- *Writing with the Stylus on page 10*
- *Resetting the SPT 1800 on page 12*
- *Attaching the Handstrap on page 13*
- *Scanning 1-D Bar Codes on page 14*
- *Scanning PDF417 (2-D) Bar Codes on page 14*
- *Initiating a Network Connection on page 15*
- *Maintaining the SPT 1800 on page 16*
- *Troubleshooting on page 17.*

The *SPT 1800 Product Reference Guide* (p/n 72-51337-xx), available from [www.symbol.com/manuals](http://www.symbol.com/manuals), details the applications available on the SPT 1800.

## Parts of the SPT 1800

The following illustration indicates each part of the SPT 1800.

### Front View

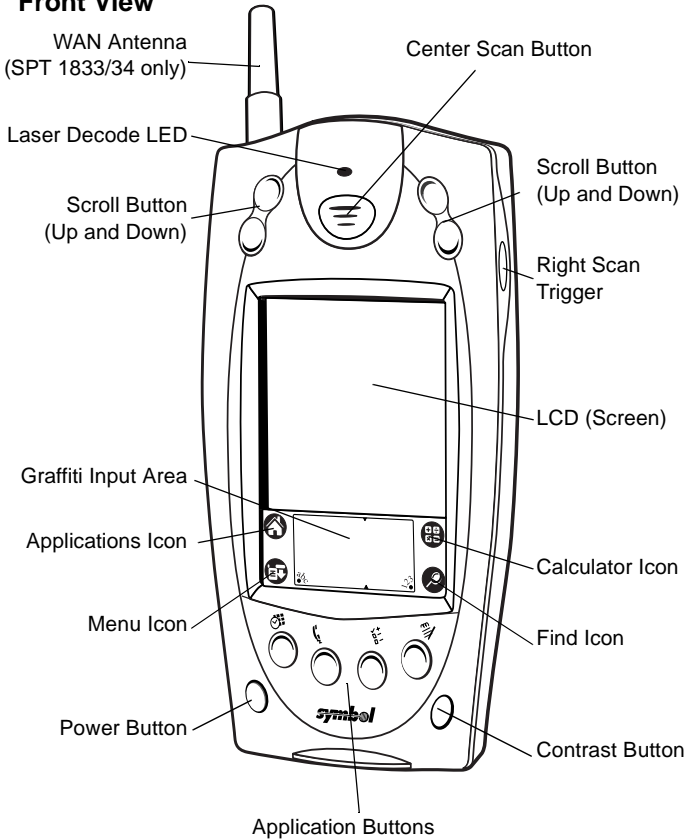

## Parts of the SPT 1800 (continued)

**Left View**

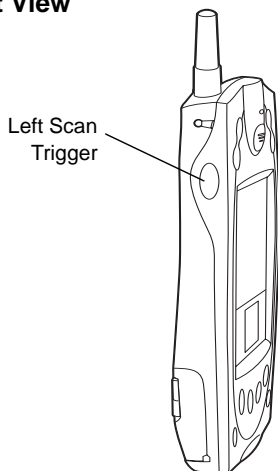

**Top View**

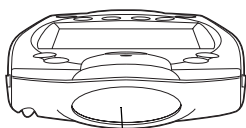

Scanner Exit Window

**Bottom View**

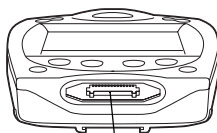

Serial Port

## Parts of the SPT 1800 (continued)

### Back View

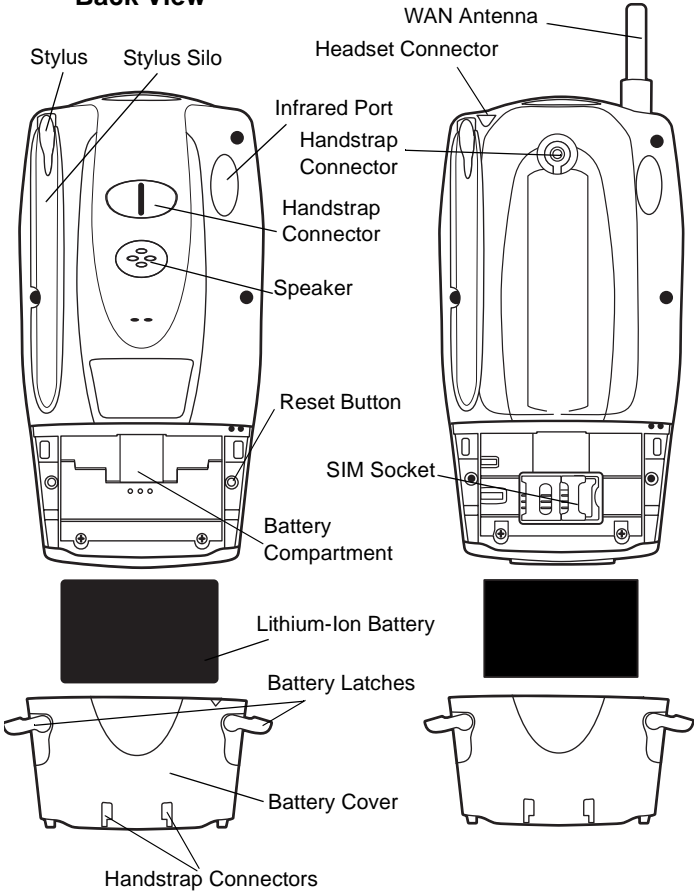

## Getting Started

Before you can use your SPT 1800, perform the basic setup procedures:

- Install the SIM card (SPT 1834 only)
- Install and charge the battery
- Start the SPT 1800
- Initiate the network connection (SPT 183X/184X only).

## Installing the SIM Card (SPT 1834 Only)

Open the latches on the battery cover and lift it away from the SPT1834.

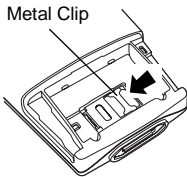

1. Slide the metal clip to the left to release the SIM cardholder.

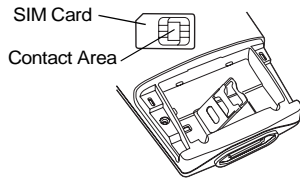

2. Lift the cardholder to an upright position.

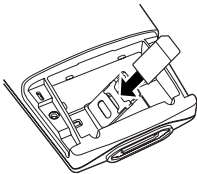

3. Insert the card between the cardholder body and the metal clip; be sure the beveled corner of the SIM card is on the top.

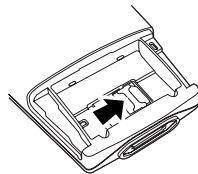

4. Close the cardholder (with the contact area of the card facing down).
5. Slide the metal clip to the right to lock it in place.

## Installing the Battery

1. Open the latches on the battery cover and lift it away from the SPT 1800.
2. Insert the lithium-ion (Li-ion) battery into the battery compartment, ensuring that it snaps into place.

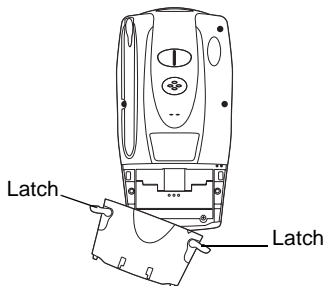

3. Replace the battery cover and close the latches.

**Note:** Keep the battery latches completely open while securing the battery cover.

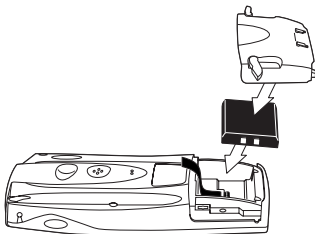

## Charging the Battery

**Note:** The SPT 1833 must use 1550 mAh Lithium-ion battery (p/n 21-52319-01). All other SPT 1800 Series terminals use Lithium-ion battery (p/n 20-36098-01).

Before using your SPT 1800 for the first time, charge the battery using the cradle, the Synchronization/Charging Cable or the Universal Battery Charger (UBC). For instructions on using the UBC, see the *UBC Quick Reference Guide*.

---

**Caution:** The main battery charges the backup battery in the SPT 1800. Once the battery is fully charged, do not remove it from the SPT 1800 for 24 hours. During this period, the SPT 1800 cannot maintain any user data if the battery is removed from the terminal.

---



### **Using the Cradle to Charge the Battery**

1. Ensure the battery is installed in the terminal.
2. Plug the cradle into a wall outlet.
3. Insert the SPT 1800 into the cradle.

The terminal's battery is fully charged after approximately two hours. You can also charge a spare battery by inserting it into the spare battery charging slot on the back of the single slot cradle. The spare battery fully charges in approximately 2.5 hours. See the *CRD 1800 Cradle Quick Reference Guide* for more information.

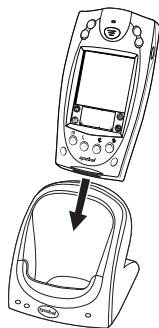

**Note:** When the battery is fully charged, the cradle's charging LED lights green. The CRD1700-1000S Single Slot Serial Cradle and CRD1700-1000M Modem Cradle are designed for use with the SPT 1700 Series terminals only. Please ensure that you are using the correct cradle with the correct terminal.

### **Using the Synchronization/Charging Cable to Charge the Battery**

1. Ensure the battery is installed in the terminal.
2. Insert the cable into the bottom of the terminal.

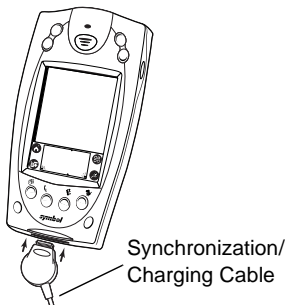

3. Plug the power cable into a wall outlet and plug the other end into the battery charging receptacle on the side of the Synchronization/Charging Cable.

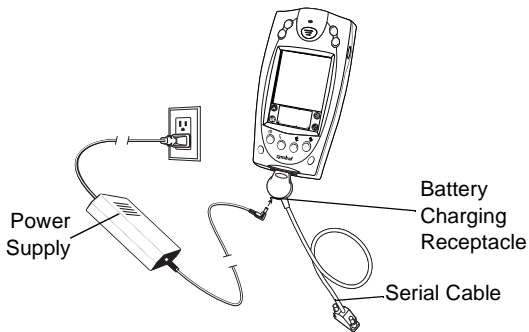

The battery is fully charged after approximately two hours.

## Starting the SPT 1800

Press the red power button to power on the terminal. If the terminal does not power on, perform a hard reset. See [Performing a Hard Reset on page 12](#).

## Calibrating the Screen

The first time you start your SPT 1800, the Welcome utility appears. Follow the steps to align the internal circuitry of your SPT 1800 with its touch-sensitive screen, and to set the current time and date.

**Note:** If your SPT 1800 unit came pre-loaded with a custom software application, you may not need to calibrate your screen, in which case you will not see the Welcome utility.

## Q u i c k R e f e r e n c e

1. Press the power button on the front panel of your SPT 1800 to display the Welcome utility (This also displays following a hard reset).



Note: If necessary, adjust the contrast control on the SPT 1800 so the screen is clear and readable. See [Contrast Control on page 10](#) for instructions.

2. Follow the instructions on the screen.
3. Tap the exact center of each target that appears on the screen with the tip of the stylus.

If, at any time you need to recalibrate the screen, open the *Preferences* application, tap *General* on the top right corner of the screen and select the *digitizer* option from the pull down menu.

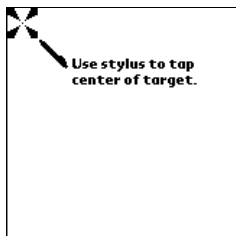

## Using the SPT 1800

### Power Button/Backlight Control

The power button turns the SPT 1800 on and off. This button also serves as your backlight control for low-light conditions. When the SPT 1800 is on, press and hold the power button for approximately two seconds to turn the backlight on and off.

## Contrast Control

The contrast control button is located on the lower right-hand side of the SPT 1800.



1. Press the contrast control button to display the contrast adjusting bar on the screen.
2. Using your stylus, adjust the contrast by scrolling the contrast bar until the contrast is set to the desired level, or use either of the scroll buttons on the top of the terminal to adjust the contrast level.
3. Press the contrast control button or tap Done on the screen to turn off the contrast control.

## Writing with the Stylus

Your SPT 1800 includes Graffiti<sup>®</sup> handwriting software for entering text and numbers. Graffiti translates stylus strokes into letters or numbers. See the *SPT 1800 Product Reference Guide* (p/n 72-51337-xx) for more information.

## On-screen Keyboard

You can activate the on-screen keyboard any time you need to enter text or numbers on your SPT 1800. Note that you cannot enter Graffiti characters while using the on-screen keyboard.



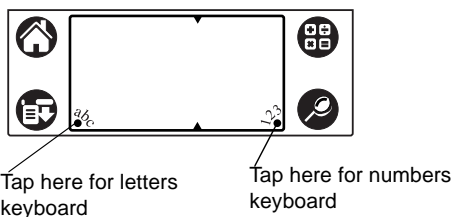

1. Open any application.
2. Tap any record name, or tap the *New* button with the tip of the stylus.

## Q u i c k R e f e r e n c e

3. Tap the left target to open the Alpha keyboard, or tap the right target to open the Numeric keyboard.



### Icon Descriptions

	<b>Applications Icon</b>	Exits the current application and lists available applications for selection.
	<b>Calculator Icon</b>	Displays the calculator application.
	<b>Menu Icon</b>	Tap from within an application to display the options menu for the application.
	<b>Find Icon</b>	Tap from within an application to enter search criteria to find an entry.

### Using a Headset (SPT 1834 Only)

To use a headset with the SPT 1834, plug the headset jack into the audio connector on the top of the terminal.

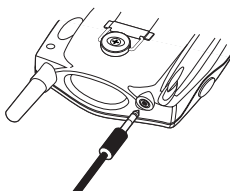

## Resetting the SPT 1800

If your SPT 1800 stops responding to input, you may need to perform a reset.

### Performing a Soft Reset

A soft reset restarts the SPT 1800 and saves all records and entries stored in your SPT 1800 terminal. After a soft reset, the Palm Computing Platform® Logo screen appears followed by the General Preferences screen.

To perform a soft reset, remove the battery cover and gently press the reset button located under the battery cover.

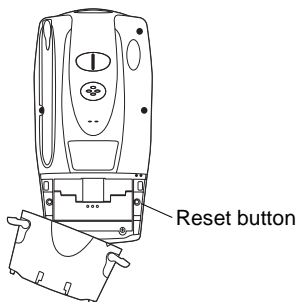

### Performing a Hard Reset

A hard reset also restarts your terminal, but erases all records and entries stored in your SPT 1800. *Therefore, never perform a hard reset unless a soft reset does not solve your problem.*

**Note:** You can restore any data previously synchronized with your computer during the next HotSync operation.

1. Remove the battery cover.
2. Hold down the power button on the front of the SPT 1800, and gently press the reset button.
3. Release the reset button, then release the power button when the Palm logo appears.
4. When a message appears on the screen warning that you are about to erase all data, do one of the following:
  - a. Press the upper half of a scroll button to complete the hard reset.
  - b. Press any other button to perform a soft reset.

**Note:** With a hard reset, the current date and time are retained. Formats, preferences and other settings are restored to their factory default settings.

## Attaching the Handstrap

The SPT 1800 has a handstrap which increases comfort when holding it for extended periods of time.

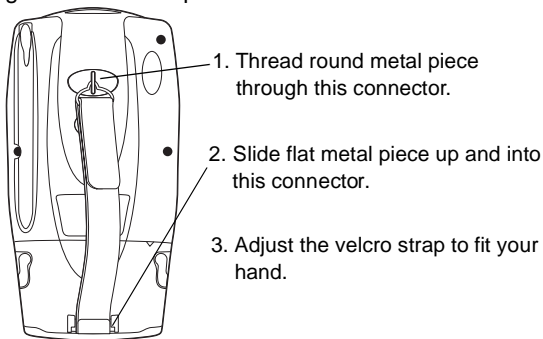

To attach the handstrap for the SPT 1834:

1. Put the side slots of the threaded button over the wire clips on the handstrap.
2. Screw the button into the threaded slot on the back of the terminal.
3. Slide the flat metal piece into the handstrap connection on the bottom of the terminal.

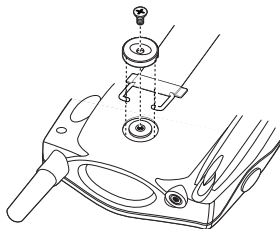

## Scanning 1-D Bar Codes

The SPT 1800 has an integrated laser bar code scanner which allows you to collect data by scanning bar codes if your unit is configured with a scanning application. To scan bar codes:

1. Start your scanning application.
2. Aim the scanner at a bar code.
3. Press either the right, left or center scan trigger. Make sure the red scan beam covers the entire bar code. The green scan LED lights and a beep sounds to indicate a successful decode.

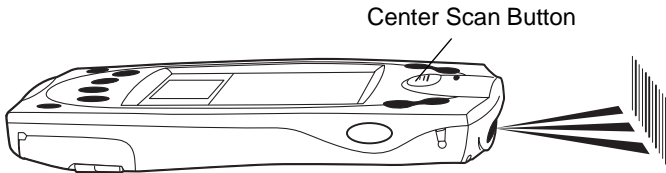

## Scanning PDF417 (2-D) Bar Codes

To scan a PDF417 bar code (with a 2-D configured terminal):

1. Aim the scanner at the PDF bar code and press either the right, left, or center scan trigger.
2. Hold the trigger down and keep the scan line parallel to the rows of the symbol.
3. Manually raster the scan line by slowly moving the scanner up and down so it scans the entire bar code at a rate of one inch per second.





## Q u i c k R e f e r e n c e

A clicking noise lets you know the 2-D bar code is being decoded. If there is no clicking noise when you are scanning, the bar code is not being scanned properly.

When decoding a very long 2-D bar code, you may notice a slight delay between the time when the terminal completes the decode and the time when the data is displayed on the screen. The first beep you hear indicates a successful decode. The second beep you hear indicates the data has been received by the host. Do not attempt to decode another bar code until you hear the second beep and see the green LED indicating a successful decode.

To improve PDF decoding:

- Check that PDF417 scanning is enabled.
- Make sure the scan line extends at least 1/2" past the left and right edges of the bar code.
- Hold the scanner closer for denser symbols, farther away for larger symbols.
- Make sure you scan the top and bottom rows of the symbol.
- Be patient - it may take a few swipes to decode the symbol.

The bar code is completely decoded when you hear a tone, followed by a short, high tone beep. The green LED stays lit for three seconds or until the next trigger pull.

### **Initiating a Network Connection**

Before using the terminal, set up the Spectrum24, CDPD (Cellular Digital Packet Data) or GSM (Global System for Mobile Communication) network connection. Refer to the *SPT 1800 Series Product Reference Guide* (p/n 72-51337-xx) for setup instructions.

A small cursor blinks at the top right-hand corner of the screen when the terminal activates a radio connection (Spectrum24 or CDPD). A blinking cursor does not appear for a GSM radio

connection. A cursor does not appear if you are not connected to the radio.

## **Maintaining the SPT 1800**

For trouble-free service, observe the following tips when using your SPT 1800:

- Do not scratch the screen. Use the supplied stylus or a plastic-tipped pen intended for use with a touch-sensitive screen. Never use a pen or pencil or other sharp object on the screen.
- Although your SPT 1800 is water and dust resistant, do not expose it to rain or moisture for an extended period. Treat your SPT 1800 as you would a pocket calculator or other small electronic instrument.
- The touch-sensitive screen of your SPT 1800 contains glass. Do not subject your SPT 1800 to any strong impact.
- Protect your SPT 1800 from temperature extremes. Do not leave it on the dashboard of a car on a hot day, and keep it away from heaters and other heat sources.
- Do not store or use your SPT 1800 in any location that is extremely dusty, damp or wet.
- If the surface of the SPT 1800 screen becomes soiled, clean it with a soft lens cloth moistened with a diluted window-cleaning solution.

## Troubleshooting

Problem	Cause	Solution
SPT 1800 terminal does not turn on.	Contrast is set too light.	Adjust the contrast control.
	Battery is not fully charged.	Make sure the battery is fully charged and installed properly.
	Battery is defective.	Replace the battery. If your SPT 1800 terminal still does not operate, try a soft reset; see <a href="#">Resetting the SPT 1800 on page 12</a> .
Low battery warning after replacing the battery.	A normal condition.	The battery warning message may appear immediately after replacing the battery. In addition, if you check the battery gauge in the Applications Launcher <i>immediately</i> after replacing the battery, the gauge may start at "empty" and slowly rise to "full." This is normal. It takes a minute for the battery gauge to accurately show the condition of the battery.
No sound.	Sound setting is set to off in the <i>Preferences</i> section.	Check the Sound options in the General Preferences screen. If an option is set to off, there will be no sound. Tap the "off" setting to display a menu of options and tap the option you want.
SPT 1800 terminal turns itself off.	Terminal automatically turns itself off after a period of inactivity.	Your SPT 1800 is designed to turn itself off after a period of inactivity. This period can be set at thirty seconds, one minute, two minutes or three minutes. Check the "Auto-off after" setting in the General Preferences screen, and change the setting if you need a longer delay before the automatic shutoff feature activates. See the <i>SPT 1800 Product Reference Guide</i> for more information.  Note: The terminal also turns itself off when the battery power is extremely low.



Problem	Cause	Solution
SPT 1800 doesn't recognize my hand-writing.	You are not using Graffiti character strokes.	For your SPT 1800 to recognize hand-writing input with the stylus, you need to use the Graffiti® character strokes. See the <i>SPT 1800 Product Reference Guide</i> for information about how to write Graffiti character strokes.
	You are not writing character strokes in the correct area.	<p>Make the Graffiti character strokes in the Graffiti writing area — not on the display part of the screen.</p> <p>Make sure you are writing the strokes for letters in the left-hand side, and the strokes for numbers in the right-hand side of the Graffiti writing area.</p>
	Graffiti is shifted into extended or punctuation modes.	See the <i>SPT 1800 Product Reference Guide</i> for information about shifting into and out of punctuation modes.
Tapping the screen buttons or icons does not activate the corresponding feature.	Screen is out of calibration.	Recalibrate the digitizer. Choose Digitizer from the Preferences application pick list and follow the directions on the screen.
When I tap the Menu icon, nothing happens.	Application does not have menu item.	Not all applications or screens have menus. Try changing to a different application.
Beamed data does not transmit.	Terminals are too far apart or obstructed. File is locked.	<p>Confirm that the SPT 1800 terminals are 5" apart, the receiver has its IrDA capability enabled and that the path between the two devices is clear of obstacles.</p> <p>Note: You cannot overwrite a .prc file via IrDA if it is locked.</p>
When receiving beamed data an out of memory message appears.	Memory full.	Your SPT 1800 terminal requires at least twice the amount of memory available as the data you are receiving. For example, if you are receiving a 30K application, you must have at least 60K free.

## Q u i c k R e f e r e n c e

Problem	Cause	Solution
SPT 1800 does not accept scan input.	Scan application not present.	Verify that the SPT 1800 is loaded with a scanning application. See your System Administrator.
	Bad bar code.	Check to be sure the bar code symbol is not defaced.
	Too far away from bar code.	Be sure you are within proper scanning range.
	Bar code type is not enabled.	Be sure the SPT 1800 is programmed to accept the type of bar code you are scanning.
	Beep is not enabled.	If you are expecting a beep on a good decode and don't hear one, check that the application is set to generate a beep on good decode.
	Battery is low.	If the scanner stops emitting a laser beam when you press the trigger, check your battery level. When the battery is low, the scanner shuts off before the terminal notifies you of the low battery condition.  Note: If, after performing these checks, the scanner is still not reading symbols, contact your distributor or Symbol Technologies.

## Ergonomic Recommendations

**Caution:** In order to avoid or minimize the potential risk of ergonomic injury follow the recommendations below. Consult with your local Health & Safety Manager to ensure that you are adhering to your company's safety programs to prevent employee injury.

- Reduce or eliminate repetitive motion
- Maintain a natural position
- Reduce or eliminate excessive force
- Keep objects that are used frequently within easy reach
- Perform tasks at correct heights
- Reduce or eliminate vibration
- Reduce or eliminate direct pressure
- Provide adjustable workstations
- Provide adequate clearance
- Provide a suitable working environment
- Improve work procedures.

## Regulatory Information

All Symbol devices are designed to be compliant with rules and regulations in locations they are sold and will be labeled as required.

Any changes or modifications to Symbol Technologies equipment, not expressly approved by Symbol Technologies, could void the user's authority to operate the equipment.



### Laser Devices

Symbol products using lasers comply with US 21CFR1040.10, and IEC825-1:1993, EN60825-1:1994+A11:1996. The laser classification is marked on one of the labels on the device.

Class 1 Laser devices are not considered to be hazardous when used for their intended purpose. The following statement is required to comply with US and international regulations:

**Caution:** Use of controls, adjustments or performance of procedures other than those specified herein may result in hazardous laser light exposure.

Class 2 laser scanners use a low power, visible light diode. As with any very bright light source, such as the sun, the user should avoid staring directly into the light beam. Momentary exposure to a Class 2 laser is not known to be harmful.

## Scanner Labeling

SPT 1800

SPT 1834

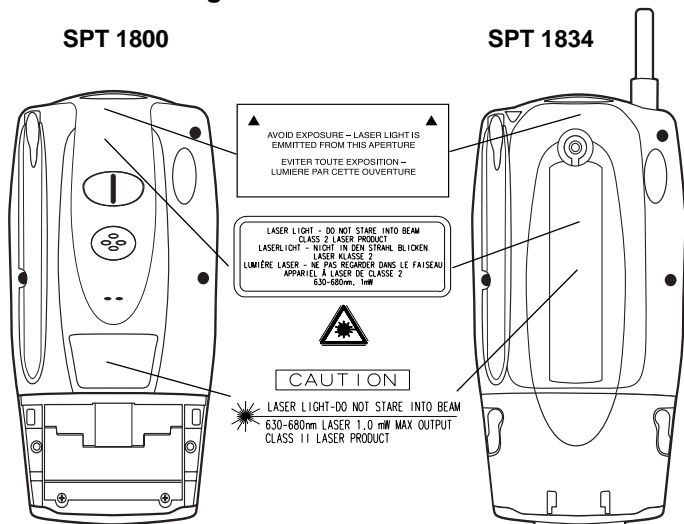

# Q u i c k R e f e r e n c e

In accordance with Clause 5, IEC 0825 and EN60825, the following information is provided to the user:



<p><b>ENGLISH</b>            CLASS 1            CLASS 2</p>	<p>CLASS 1 LASER PRODUCT            LASER LIGHT            DO NOT STARE INTO BEAM            CLASS 2 LASER PRODUCT</p>	<p><b>HEBREW</b></p>	<p>מוצר לייזר רמה 1            אור לייזר            אין להביט אל תוך הזרם            מוצר לייזר רמה 2</p>	<p>רמה 1            רמה 2</p>
<p><b>DANISH</b>            KLASSE 1            KLASSE 2</p>	<p>KLASSE 1 LASERPRODUKT            LASERLYF            SE IKKE IND I STRÅLEN            KLASSE 2 LASERPRODUKT</p>	<p><b>ITALIAN</b>            CLASSE 1            CLASSE 2</p>	<p>PRODOTTO AL LASER DI CLASSE 1            LUCE LASER            NON FISSARE IL RAGGIOPRODOTTO            AL LASER DI CLASSE 2</p>	
<p><b>DUTCH</b>            KLASSE 1            KLASSE 2</p>	<p>KLASSE-1 LASERPRODUKT            LASERLICHT            NIET IN STRAAL STAREN            KLASSE-2 LASERPRODUKT</p>	<p><b>NORWEGIAN</b>            KLASSE 1            KLASSE 2</p>	<p>LASERPRODUKT, KLASSE 1            LASERLYS IKKE STIRR INN ILSYSSTRÅLEN            LASERPRODUKT, KLASSE 2</p>	
<p><b>FINNISH</b>            LUOKKA 1            LUOKKA 2</p>	<p>LUOKKA 1 LASERTUOTE            LASERVALO            ÄLÄ TUJOTA SÄDETTÄ            LUOKKA 2 LASERTUOTE</p>	<p><b>PORTUGUESE</b>            CLASSE 1            CLASSE 2</p>	<p>PRODUTO LASER DA CLASSE 1            LUZ DE LASER NÃO FIXAR O RAIOS LUMINOSO            PRODUTO LASER DA CLASSE 2</p>	
<p><b>FRENCH</b>            CLASSE 1            CLASSE 2</p>	<p>PRODUIT LASER DE CLASSE 1            LUMIÈRE LASER            NE PAS REGARDER LE RAYON FIXEMENT            PRODUIT LASER DE CLASSE 2</p>	<p><b>SPANISH</b>            CLASE 1            CLASE 2</p>	<p>PRODUCTO LASER DE LA CLASE 1            LUZ LASER            NO MIRE FJAJAMENTE EL HAZ            PRODUCTO LASER DE LA CLASE 2</p>	
<p><b>GERMAN</b>            KLASSE 1            KLASSE 2</p>	<p>LASERPRODUKT DER KLASSE 1            LASERSTRAHLEN            NICHT DIREKT IN DEN LASERSTRAHL SCHAUEN            LASERPRODUKT DER KLASSE 2</p>	<p><b>SWEDISH</b>            KLASS 1            KLASS 2</p>	<p>LASERPRODUKT KLASS 1            LASERLJUS STIRRA INTE MOT STRÅLEN            LASERPRODUKT KLASS 2</p>	



## FCC RF Exposure Guidelines

This device was tested for typical body-worn operations with the holster providing a minimal spacing of 2.0 cm from the body to the back of the terminal/ antenna. To maintain compliance with FCC RF exposure compliance requirements, use only belt-clips, holsters, or similar accessories that maintain a 2.0 cm separation distance between the user's body and the back of the terminal, including the antenna. The use of third-party belt-clips, holsters and similar accessories should not contain metallic components in its assembly. The use of these accessories that do not satisfy these requirements may not comply with FCC RF exposure compliance requirements, and should be avoided.



## **GSM Regulatory Warnings**

### ***Emergency Calls***

The Worldwide GSM standard provides a single uniform number, 112, to dial in cases of emergency.

Provided that your phone has found a network you will be able to make an emergency call. The call can be made regardless of any security codes and depending on a network, with or without a SIM card inserted.

### **Safety Information**

The device complies with Internationally recognized standards covering Specific Absorption Rate (SAR) related to human exposure to electromagnetic fields from mobile phones.

It is advisable only to use the device only in the normal operating position.

### ***Safety on the Road***

Drivers are advised not to use the handset while their vehicle is in motion, except in emergencies. Use the hands-free facility to speak only if it does not divert your attention from the traffic.

### ***Safety on Aircraft***

You are required to switch off mobile phones when on board an aircraft or at any other time when instructed to do so by a member of the crew.

### ***Pacemakers***

It is recommended by pacemaker manufacturers that a minimum of 15cm (6 inches) be maintained between a handheld wireless phone and a pacemaker to avoid any possible interference with the pacemaker. These recommendations are consistent with the independent research by and recommendations of Wireless Technology Research.

### ***Persons with Pacemakers***

- Should always keep the device more than 15cm (6 inches) from their pacemaker when turned on
- Should not carry the device in a breast pocket
- Should use the ear furthest from the pacemaker to minimize the potential for interference.

If you have any reason to suspect that interference is taking place turn off your device immediately.



## ***Hearing Aids***

The device may interfere with some hearing aids. In the event of interference you may want to consult your hearing aid supplier to discuss solutions.

## ***Other Medical Devices***

The device transmits radio frequency energy and has the potential to interfere with inadequately protected medical devices. Consult your physician or the manufacturer of the device to see if any particular device has sufficient protection.

It is good practice to turn off the device within a hospital or other medical facility where sensitive medical equipment is in use. In some countries, this is a legal requirement applying to all mobile phones and related equipment.

## ***Effect on Vehicles***

RF signals may affect improperly installed or inadequately shielded electronic systems in motor vehicles (including safety systems). Check with the manufacturer or its representative regarding your vehicle. You should also consult the manufacturer of any equipment that has been added to your vehicle.

## ***Warning Notices***

Please observe all warning notices with regard to the usage of mobile phones.

## ***Potentially Hazardous Atmospheres***

You are advised not to use this device at a refuelling point. You are reminded of the need to observe restrictions on the use of radio devices in fuel depots, chemical plants etc.

## **Radio Frequency Interference Requirements**

Note: This equipment has been tested and found to comply with the limits for a Class B digital device, pursuant to Part 15 of the FCC rules. These limits are designed to provide reasonable protection against harmful interference in a residential installation. This equipment generates, uses, and can radiate radio frequency energy and, if not installed and used in accordance with the instructions, may cause harmful interference to radio communications. However there is no guarantee that interference will not occur in a particular installation. If this equipment does cause harmful interference to radio or television reception, which can be determined by turning the equipment off and on, the user is encouraged to try to correct the interference by one or more of the following measures:

- Reorient or relocate the receiving antenna
- Increase the separation between the equipment and receiver
- Connect the equipment into an outlet on a circuit different from that to which the receiver is connected
- Consult the dealer or an experienced radio/TV technician for help.

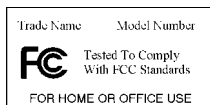



## Radio Frequency Interference Requirements - Canada

This device complies with RSS 210 of Industry & Science Canada. Operation is subject to the following two conditions: (1) this device may not cause harmful interference and (2) this device must accept any interference received, including interference that may cause undesired operation.

This Class B digital apparatus complies with Canadian ICES-003.

Cet appareil numérique de la classe B est conforme à la norme NMB-003 du Canada.

## CE Marking and European Economic Area (EEA)

2.4 GHz devices for use through the EEA have the follow restrictions:

- Maximum radiated transmit power of 10 mW EIRP in the frequency range 2.400 - 2.4835 GHz
- France, equipment is restricted to 2.4465 - 2.4835 GHz frequency range.
- Italy requires a user license for outside usage.

### **Statement of Compliance**

Symbol Technologies, Inc., hereby, declares that this device is in compliance with the essential requirements and other relevant provisions of Directives 1999/5/EC, 89/336/EEC and 73/23/EEC. Declaration of Conformities may be obtained from <http://www2.symbol.com/doc/>.

Symbol Technologies, Inc., hereby declares that this device is in compliance with all the applicable Directives, 89/336/EEC, 73/23/EEC. A Declaration of Conformity may be obtained from <http://www2.symbol.com/doc/>.

### **Other Countries**

Mexico - Restrict Frequency Range of: 2.450 - 2.4835 GHz.

## Battery Caution

---

Caution: There is a danger of explosion if battery is incorrectly replaced. Replace only with the same or equivalent type recommended by the manufacturer. Dispose of used batteries according to the manufacturer's instructions.

---

## **Warranty**

Symbol Technologies, Inc. ("Symbol") manufactures its hardware products in accordance with industry-standard practices. Symbol warrants that for a period of twelve (12) months from date of shipment, products will be free from defects in materials and workmanship.

This warranty is provided to the original owner only and is not transferable to any third party. It shall not apply to any product (i) which has been repaired or altered unless done or approved by Symbol, (ii) which has not been maintained in accordance with any operating or handling instructions supplied by Symbol, (iii) which has been subjected to unusual physical or electrical stress, misuse, abuse, power shortage, negligence or accident or (iv) which has been used other than in accordance with the product operating and handling instructions. Preventive maintenance is the responsibility of customer and is not covered under this warranty.

Wear items and accessories having a Symbol serial number, will carry a 90-day limited warranty. Non-serialized items will carry a 30-day limited warranty.

### ***Warranty Coverage and Procedure***

During the warranty period, Symbol will repair or replace defective products returned to Symbol's manufacturing plant in the US. For warranty service in North America, call the Symbol Support Center at 1-800-653-5350. International customers should contact the local Symbol office or support center. If warranty service is required, Symbol will issue a Return Material Authorization Number. Products must be shipped in the original or comparable packaging, shipping and insurance charges prepaid. Symbol will ship the repaired or replacement product freight and insurance prepaid in North America. Shipments from the US or other locations will be made F.O.B. Symbol's manufacturing plant.

Symbol will use new or refurbished parts at its discretion and will own all parts removed from repaired products. Customer will pay for the replacement product in case it does not return the replaced product to Symbol within 3 days of receipt of the replacement product. The process for return and customer's charges will be in accordance with Symbol's Exchange Policy in effect at the time of the exchange.

Customer accepts full responsibility for its software and data including the appropriate backup thereof.

Repair or replacement of a product during warranty will not extend the original warranty term.

Symbol's Customer Service organization offers an array of service plans, such as on-site, depot, or phone support, that can be implemented to meet customer's special operational requirements and are available at a substantial discount during warranty period.

### ***General***

Except for the warranties stated above, Symbol disclaims all warranties, express or implied, on products furnished hereunder, including without limitation implied warranties of merchantability and fitness for a particular purpose. The stated express warranties are in lieu of all obligations or liabilities on part of Symbol for damages, including without limitation, special, indirect, or consequential damages arising out of or in connection with the use or performance of the product. Seller's liability for damages to buyer or others resulting from the use of any product, shall in no way exceed the purchase price of said product, except in instances of injury to persons or property.

Some states (or jurisdictions) do not allow the exclusion or limitation of incidental or consequential damages, so the preceding exclusion or limitation may not apply to you.

## Service Information

Before you use the unit, it must be configured to operate in your facility's network and run your applications.

If you have a problem running your unit or using your equipment, contact your facility's Technical or Systems Support. If there is a problem with the equipment, they will contact the Symbol Support Center:

United States <sup>1</sup>	1-800-653-5350 1-631-738-2400	Canada	905-629-7226
United Kingdom	0800 328 2424	Asia/Pacific	337-6588
Australia	1-800-672-906	Austria/Österreich	1-505-5794
Denmark/Danmark	7020-1718	Finland/Suomi	9 5407 580
France	01-40-96-52-21	Germany/Deutschland	6074-49020
Italy/Italia	2-484441	Mexico/México	5-520-1835
Netherlands/Nederland	315-271700	Norway/Norge	66810600
South Africa	11-4405668	Spain/España	+913244000
Sweden/Sverige	84452900		
Latin America Sales Support	1-800-347-0178 Inside US +1-561-483-1275 Outside US		
Europe/Mid-East Distributor Operations	Contact local distributor or call +44 208 945 7360		

<sup>1</sup>Customer support is available 24 hours a day, 7 days a week.

**Visit <http://www.symbol.com/manuals> for all product manuals.**



**72-51336-01  
Revision B — December 2001**